

S700

INNOVATION BECOMES AN INVITATION.



MAKE IT
Wonderful!

FRANKE

A close-up photograph of a hand holding a metal pitcher under the spout of a coffee machine. The machine is dark-colored with a silver spout. A label on the machine reads "FRANKE". Steam is rising from the machine, and the background is blurred, showing a person's face. The text is overlaid on the right side of the image.

“Technology has created so many new opportunities and has boosted the potential of the coffee business. But coffee-making has always been and will continue to be a human art.”



An Ambitious Approach.

WHERE WILL YOU TAKE IT?

The S700 marries the best of two coffee worlds: the intelligent technology of our fully automatic A-Line combined with the creative capacity of a 2-step-machine. We call it a semi automatic.

Like a 2-step-machine, it encourages users to explore their creativity in countless ways and, like a state-of-the-art fully automatic, it offers outstanding usability and user experience. We believe this combination offers huge potential. But it will be professionals like you who decide how far you will take it.

New S-Line: S700

All the innovation of Franke's fully automatic A-Line combined with endless steam performance for manual or automatic milk foaming and creative latte art:

- **The new iQFlow™:** intelligent coffee extraction for exceptional taste profiling and absolute product consistency
- **Cutting-edge performance:** up to 160 espressos per hour
- **3-boiler system for endless steam performance**
- **8" touchscreen and intuitive UI**

Game-Changing iQFlow™

WHERE WILL YOU TAKE IT?

Up to now, we have relied mainly on the fineness of the grind to control the extraction quality. With iQFlow™, we have developed an intelligent technology that gives you access to a whole new level of flavor extraction and product consistency.

Franke has developed a technology that invites you to get the fullest flavor potential out of your roast and test out new flavor profiles. For the first time ever, it is now possible to preprogram the shot time and amount of water used in order to define individual extraction results for every product as well as to ensure consistency in every cup.



Get more flavor out of the beans

iQFlow™ optimizes the extraction process and brings more aroma into every cup; we call it Intelligent Coffee Extraction.



Define your individual extraction profiles

You no longer have to work with only one taste profile; you can define individual taste profiles for every product.

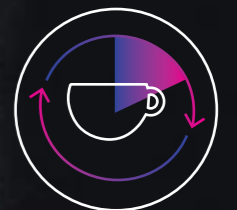

Ensure product consistency every time

With iQFlow™, you can enjoy fixed shot times and absolute consistent product quality for every cup, every day, at every location.

Learn more about iQFlow™ at franke.coffee/iqflow

Wonderful Latte Art.

WHERE WILL YOU TAKE IT?

Preparing a unique cup of coffee has always been an art that requires creativity and passion. With the S700 our engineers have just one goal: to create the most intuitive workspace that enables professionals to unleash their full creative potential.

An excellent example of this boundless creativity is latte art, a special addition to any cup of coffee that is intended to do exactly one thing: put a smile on a customer's face. The S700 is not just a coffee machine; it is the most advanced instrument that helps professional baristas to not only perform their work, but to truly perfect their craft.

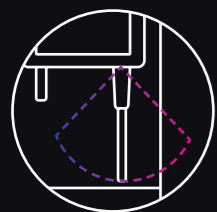

A steam spout engineered for professionals

With a larger radius of action and a robust design. And with an integrated temperature sensor for the perfect foam.

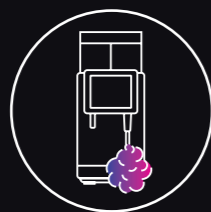

3-boiler system for endless steam and foam

You have all the steam you need to create as much perfect handmade foam as you want, as well as all the hot water you need.



With Autosteam or Autosteam Pro

The steam spout can either support your manual milk foaming process (Autosteam, with integrated temperature sensor) or it can foam milk fully automatically (Autosteam Pro).

An Unrivaled User Experience.

WHERE WILL YOU TAKE IT?

The S700 enables professionals to create the ultimate coffee adventure through a UI experience covering all multitasking requirements.

Customers nowadays have great expectations when it comes to coffee shops. Operators and baristas are therefore in high demand and every element of everything they do needs to be perfect. The intuitive touchscreen enables them to optimize their working process, their productivity, and the quality of their coffee creations. Use your workflow to turn your customer's every coffee moment into a truly unique experience.



Touch it and it will serve you

An 8" touchscreen makes all recipes available at a tap and enhances the barista's performance with an intelligent Queueing System.



Touch it and it will lead you

For example, let the machine assist your staff in cleaning and maintenance by following an image-based process on the display.

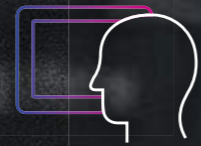

Use it to interact with your staff

Information about the origin of your beans? Cross-selling campaigns and brand? Use the screen to promote ideas, to share information, and to support your sales activities.

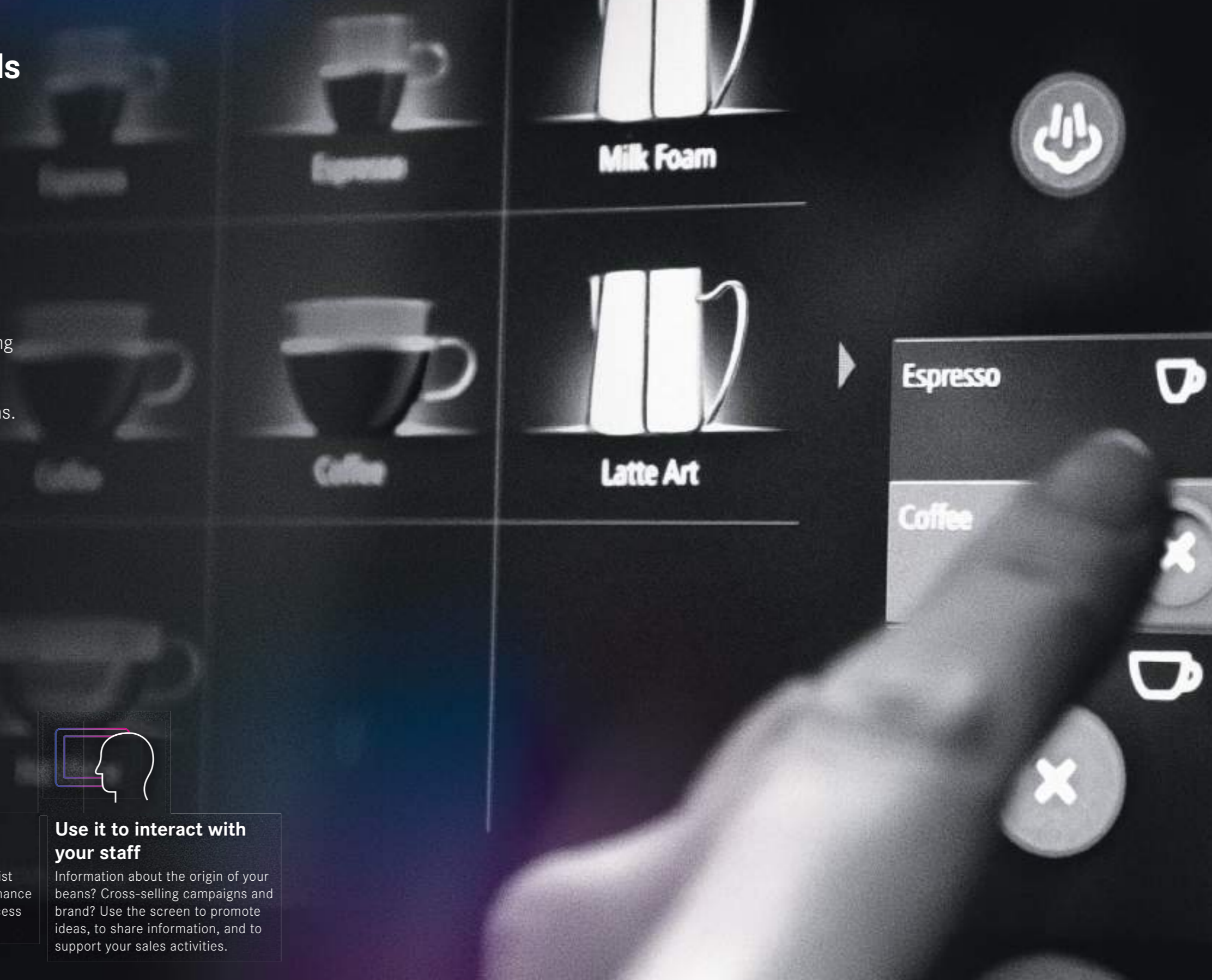

Your Success.

WHERE WILL YOU TAKE IT?

What does it take to successfully create memorable, daily experiences in the challenging coffee business? Staff with professional attitude and exceptional motivation, of course, plus the S700 with its innovative and ground-breaking technology.

The S700 offers impressive and unique qualities: minimal adjustment is needed even during long-term use; maintenance and cleaning require little input, cutting service costs; optimum reliability builds a trusting collaboration. Staff members will be able to tend to the clientele rather than the machine. All of this guarantees attentive employees, consistent premium coffee experiences, satisfied customers, and greater success overall.



Two grinders for more bean variety

S700 equipped with two grinders as standard.

160

More coffees

Best-in-class performance with up to 160 espressos per hour.

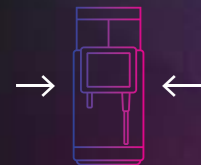

More space

The S700 is only 340 millimeters wide.



More smiles from customers

iQFlow™ guarantees premium extraction plus an enhanced customer experience.



More smiles from your staff

The S700 guides the user through simple cleaning and profiling processes using its visual UI, is equipped with a temperature sensor for better milk foam, and much more. This allows your team to focus solely on the customer and create a unique brand experience.



More profitability

Thanks to iQFlow™, baristas no longer need to manually adjust the coffee machine in order to regulate the fineness of the grind. This reduces unproductive time spent operating the machine.

Intelligent Design.





S700 OPTIONS

- Coffee grounds ejector
- Raised feet (100 mm)
- Autosteam Pro (automatic milk foaming)

CUP WARMER

With four heatable trays

COLORS

-  Black/chrome
-  Anthracite/chrome

PRODUCT SPECIALTIES	S700
Ristretto Espresso	✓
Coffee Café crème	✓
Brewed coffee	✓
Cappuccino Latte macchiato	(✓)
Chococcino	
Chocolate	
Hot milk	(✓)
Hot milk foam	(✓)
Cold milk	
Cold milk foam	
Hot water	✓
Steam	✓

MACHINE MODELS

MODEL	POWER
S700	380-415V 3LNPE 50/60 Hz (16A) 220-240V 1LNPE 50/60 Hz (30A) 200-220V 3LPE 50/60 Hz (30A) 208V 2LPE 60 Hz (24A) 380V 3LNPE 50 Hz (16A)
Dimensions:	340 mm / 750 mm / 600 mm (W / H / D)

COLOR OPTIONS

Black/chrome or anthracite/chrome

WATER CONNECTION

Fixed water connection	Metal hose with union nut G3/8", L = 1500 mm
Water supply line	If possible on installation side: untreated water of drinking water quality (not from household decalcification system)
Water pressure	80-800 kPa (0.8-8.0 bar)
Total hardness	4-8 °dH GH (German total hardness) / 7-14 °fH GH (French total hardness) / 70-140 ppm (mg/l)
Carbonate hardness	3-6 °dH KH (carbonate hardness) / 50-105 ppm (mg/l)
Acid content/pH value	6.5-7.5 pH
Chlorine content	< 0.5 mg/l

WATER DRAIN

Drain hose Dia. = 16 mm, L = 2000 mm

CUP WARMER CW

Electrical connection:	220-240V 1LNPE 50/60 Hz 120 W (10 A) 110 V 1LNPE 50/60 Hz 80 W (10 A)
Dimensions:	270 mm / 540 mm / 454 mm (W/H/D)
Weight (empty):	approx. 20 kg
Colors:	Black or anthracite

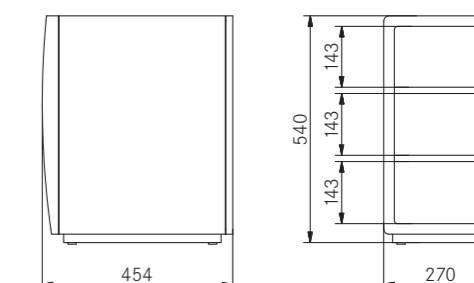
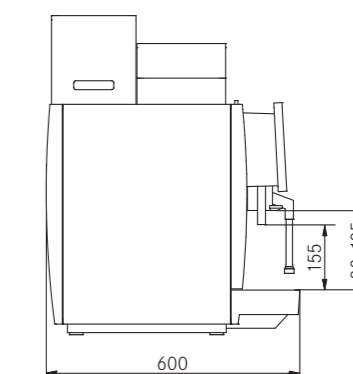
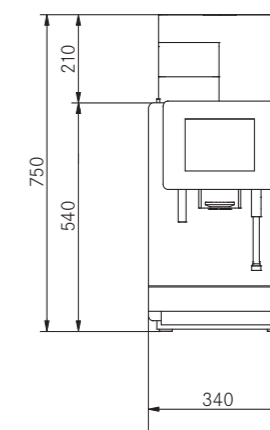



Franke Kaffeemaschinen AG
Franke-Strasse 9
4663 Aarburg
Switzerland
Phone +41 62 787 31 31
www.franke.com

Franke Coffee Systems GmbH
Franke Strasse 1
97947 Grünsfeld
Germany
Phone +49 9346 9278 0
Fax +49 9346 9278 100
www.franke.de

Franke Coffee Systems
UK Limited
6A Handley Page Way,
Old Parkbury Lane,
Colney Street,
St Albans,
Hertfordshire, AL2 2DQ
England
Phone +44 1923 635700
Fax +44 1923 635701
www.franke.com

Franke Coffee Systems
North America
800 Aviation Parkway
Smyrna, TN 37167
USA
Phone +1 615 462 4265
Fax +1 615 462 4400
www.franke.com

FRANKE