

USER MANUAL A1000

FCS4050



Read the user manual before working on the machine.

Keep the manual with the machine and pass the manual on to the next operator if the machine is sold or transferred to a third party.



IT'S ALL ABOUT THE MOMENT

Discover more at coffee.franke.com

FRANKE

TABLE OF CONTENTS

1	For your safety	7
1.1	Intended use	7
1.1.1	Coffee machine	7
1.1.2	Add-on units	7
1.2	Prerequisites for using the coffee machine	8
1.3	Explanation of safety instructions	8
1.4	Safety concerns when using the coffee machine	9
2	Explanation of symbols	12
2.1	Symbols used in the manual	12
2.1.1	Orientation	12
2.2	Symbols used in the software	12
2.2.1	Symbols used for navigation and operation	12
2.2.2	Symbols on the dashboard and on the user interface	12
2.2.3	Depiction of error messages	14
3	Scope of delivery	16
4	Identification	18
4.1	Position of type plates	18
4.1.1	Coffee machine	18
4.1.2	Cooling unit SU12/UT12	18
4.1.3	Flavor Station FS	18
4.1.4	Under-counter Flavor Station FSU	19
4.1.5	CW (option)	19
4.1.6	AC200 (Option)	19
4.1.7	MU FM EC	19
4.2	Type code	20
4.2.1	Coffee machine	20
4.2.2	Add-on units	20
5	Description of machine	21
5.1	Coffee machine	21
5.1.1	Standard	21
5.1.2	Options	22
5.1.3	Coffee machine components	24
5.2	Add-on units	25
5.2.1	Cooling unit	25
5.2.2	Flavor Station	25
5.2.3	Cup warmer	26
5.2.4	Accounting system	26
5.2.5	Pump module MU FM EC	26
5.3	Overview of operating modes	26
5.3.1	User interface	27
5.3.2	Cash Register operating mode	27
5.3.3	Quick Select operating mode	27
5.3.4	Operating modes in combination with Credit Mode	28
5.4	Franke Digital Services (option)	28

6	Installation	29
6.1	Preparations	29
6.2	Dimensions	29
6.2.1	Feet	31
6.3	Requirements of the water supply	31
6.3.1	Main water connection	31
6.3.2	Water quality	31
6.3.3	Water outlet	32
7	Filling and emptying	33
7.1	filling the machine	33
7.2	Filling beans	33
7.3	Filling powder	34
7.4	Filling the cooling unit	34
7.4.1	Cooling unit SU12/UT12	35
7.5	Filling refrigerator (with pump module (MU))	36
7.6	Filling the Flavor Station	37
7.7	Setting the grind coarseness	38
7.8	Emptying the bean hopper	40
7.9	Emptying the powder hopper	40
7.10	Emptying the grounds container	41
7.11	Emptying the cooling unit	42
7.11.1	Cooling unit SU12/UT12	42
7.12	Emptying the refrigerator (with pump module (MU))	43
7.13	Emptying the Flavor Station	44
8	Preparing beverages	45
8.1	Preparing beverages with Quick Select	45
8.2	Preparing beverages with Cash Register	45
8.3	Preparing beverages with ground coffee	46
8.4	Preparing hot water	47
8.5	Steam dispenser (Autosteam/Autosteam Pro)	48
8.6	Preparing beverages using the touchpad	48
9	Cleaning	49
9.1	Introduction	49
9.2	Required cleaning accessories	49
9.3	5-step method	49
9.4	Starting the cleaning process	50
9.4.1	Starting cleaning via the Cleaning and Maintenance menu	50
9.4.2	Start cleaning for cooling unit SU12 CM	51
9.5	Cleaning the aerator	52
9.6	Weekly cleaning	52
9.6.1	Cleaning the machine surface	52
9.6.2	Cleaning the bean hopper and powder hopper	53

9.6.3	Cleaning the screen	54
9.7	Rinsing the coffee machine	54
10	Configuration	56
10.1	Calling up the maintenance level	56
10.2	PIN codes	56
10.3	My settings menu tree	56
10.4	Input methods	57
10.5	My settings	57
10.5.1	Menu 0 Commissioning	57
10.5.2	Menu 1 Set Machine	58
10.5.3	Menu 2 Customize beverages	64
10.5.4	Menu 3 Date and time	66
10.5.5	Menu 4 Nutritional value information	68
10.5.6	Menu 6 Access rights	69
11	Individualization and data transfer	73
11.1	Overview	73
11.2	Individualization and data transfer menu tree	73
11.3	Multimedia functions	73
11.4	Manage Digital Signage via USB stick	74
11.5	Configure application	74
11.5.1	Language settings	75
11.5.2	Operating mode	75
11.5.3	Display [Operating mode]	76
11.5.4	Nutritional value settings	76
11.5.5	Accounting	76
11.5.6	Cup detection	76
11.5.7	Cup monitoring	77
11.5.8	Edge lighting	77
11.5.9	Transaction approval (API)	77
11.6	Loading/backing up data	78
11.6.1	Back up data	78
11.6.2	Load data	78
11.6.3	Back up XML data	78
11.7	Set default values	78
11.8	Activating configurations	78
12	Troubleshooting	80
12.1	Error messages	80
12.1.1	Color code for error messages	81
12.2	Troubleshooting the system	81
12.3	Tips for good coffee beverages	82
12.4	Help with problems concerning product quality	82
13	Decommissioning	84
13.1	Preparing for decommissioning	84
13.2	Back up data	84

13.3	Short-term decommissioning (up to 3 weeks)	84
13.4	Long-term decommissioning	85
13.5	Transport and storage	85
13.6	Recommissioning after prolonged periods of storage or non-use	85
14	Disposal of parts	86
15	Technical data	87
15.1	Capacities in accordance with DIN 18873-2:2016-02	87
15.2	Electrical connection data	87
	Index	88

1 FOR YOUR SAFETY

1.1 Intended use

1.1.1 Coffee machine

- The A1000 is a commercial machine for preparing beverages and is intended for use in food services, offices and other similar environments.
- The A1000 is designed to process whole coffee beans, ground coffee, powder that is suitable for automatic devices, and fresh milk.
- The A1000 is intended for the preparation of beverages in accordance with these instructions and the technical data.
- The A1000 is intended for operation indoors.

Please note

- The A1000 is not suitable for use outdoors.

1.1.2 Add-on units

Cooling unit

- The cooling unit is intended exclusively to keep milk cool for the preparation of coffee drinks with a Franke coffee machine.
- Only use precooled milk (2-5 °C).
- Remove the milk when the cooling unit is not in use. Store the milk in a suitable refrigerator.
- Use only the recommended cleaners. Other cleaners may leave residues in the milk system.
- The cooling unit is intended exclusively for operation indoors.
- Please also observe the Declaration of Conformity delivered with the device.

Flavor Station

- The Flavor Station is intended exclusively for the automatic conveyance of syrups and other fluid aromas for the preparation of drinks.

Please note

- The Flavor Station is not designed to pump viscous fluids such as chocolate sauce.
- The Flavor Station is not suitable for the storage of alcoholic or explosive substances.

Cup warmer

- The cup warmer is intended only for preheating coffee cups and glasses used when preparing drinks.

Please note

- Drinking containers made of paper or plastic must not be used. The cup warmer is not designed to dry dish towels or other cloths. It is not necessary to cover the cups to warm them.

Accounting system

- Depending on the version, the accounting system can be used for various methods of payment. Examples: Payment with coins, cards, or mobile payment systems.

Pump module (MU)

- The pump module (MU) is intended exclusively for pumping milk with a Franke coffee machine.
- The pump module (MU) is intended exclusively for operation in a refrigerator.
- Only use pre-cooled milk (2-5 °C).
- Use only the recommended cleaners. Other cleaners may leave residues in the milk system.

1.2 Prerequisites for using the coffee machine

- The A1000 is intended for use by trained personnel or as a self-service machine.
- Self-service machines must always be monitored to protect the users.
- Each operator of the A1000 must have read and understood the manual. This does not apply to its use in the self-service area.
- Do not operate the A1000 or add-on units until you have completely read and understood this manual.
- Do not use the A1000 or add-on units if you are not familiar with the various functions.
- Do not use the A1000 if the connection lines of the A1000 or the add-on units are damaged.
- Do not use the A1000 unless the A1000 or the add-on units have been cleaned or filled as intended.
- Children under the age of 8 are not permitted to use the A1000 and the add-on units.
- Children or persons with restricted physical, sensory or mental abilities, or lack of experience and knowledge, may only use the A1000 and the add-on units under supervision or after adequate instruction by a person responsible for their safety; they are not permitted to play with the A1000 and the add-on units.
- Children are not permitted to clean the A1000 and the add-on units.

1.3 Explanation of safety instructions

To ensure personal safety and the protection of material goods, observation of these safety instructions is imperative.

Symbol and signal word indicate the severity of the hazard.



WARNING

WARNING indicates a potential danger. **DANGER** indicates an imminent danger which, if not avoided, will result in death or serious injury.



CAUTION

CAUTION indicates a hazardous situation which, if not avoided, could result in minor or moderate injury.



NOTICE

NOTICE directs your attention to the risk of damage to machinery.

1.4 Safety concerns when using the coffee machine



WARNING

Risk of fire

If the power cord is electrically overloaded, the heat generated can cause a fire.

- a) Never use power outlet strips, multi-sockets or extension cords to connect the coffee machine to the power supply.



WARNING

Risk of fatal injury from electrocution

Damaged power cords, pipes or plugs can lead to electrocution.

- a) Do not connect any damaged power cords, pipes or plugs to the power grid.
- b) Replace damaged power cords, pipes or plugs.
If the power cord is permanently assembled, contact the service technician. If the power cord is not permanently assembled, order and use a new, original power cord.
- c) Ensure that the machine/appliance and the power cord are not near any hot surfaces such as gas or electric stoves or ovens.
- d) Ensure that the power cord is not pinched and does not chafe on sharp edges.
- e) Only pull on the plug and not on the cable when disconnecting the device from the power grid.



WARNING

Risk of fatal injury from electrocution

Liquid/moisture entering the machine or leaks can lead to electrocution.

- a) Never point a liquid or steam jet at the machine.
- b) Do not pour any liquids on the machine.
- c) Do not immerse the machine in liquid.
- d) Disconnect the machine from the power supply in the event of a leak or if liquid/moisture enters the machine.



WARNING

Risk of fatal injury from electrocution

Work, repairs or servicing improperly performed on electrical systems can lead to electrocution.

- a) Have repairs on electrical parts carried out by service technicians using original spare parts.
- b) Have servicing carried out by authorized persons with corresponding qualification only.



WARNING

Risk of scalding

Hot water is released during rinsing.

- a) Keep hands away from the spouts and nozzles during this process.
- b) Do not place anything on the drip grid.
- c) IN CASE OF SCALDING: Immediately cool the affected area and, depending on the severity of the injury, consult a doctor.

**WARNING****Risk of scalding**

Hot beverages can lead to scalding.

- a) Always be careful with hot beverages.
- b) Use only suitable drinking vessels.

**WARNING****Risk of scalding**

Hot liquids and steam escape during cleaning and can lead to scalding.

- a) Keep hands away from the spouts and nozzles during this process.

**WARNING****Risk of injury**

If objects find their way into the bean hopper or grinder, splinters may be ejected, leading to injury.

- a) Never insert any objects into the bean hopper or grinder.

**CAUTION****Cutting injuries/crushing**

The powder hoppers worm gear mechanism can cause cuts or crushing injuries.

- a) Exercise care when cleaning the powder hopper.

**CAUTION****Irritation from cleaners**

Cleaning tablets, milk system cleaning agent, and descaler can lead to irritation of the skin or eyes.

- a) Observe the hazard warnings on the label of the respective cleaner.
- b) Avoid contact with your eyes and skin.
- c) Wash your hands after coming into contact with cleaning supplies.
- d) Cleaning supplies must be kept away from beverages.

**CAUTION****Health hazard due to germ formation**

Inadequate cleaning can result in food residues accumulating in the machine and at the spouts, thereby contaminating products.

- a) Do not use the machine unless it has been cleaned according to the instructions.
- b) Clean the machine daily in accordance with the instructions.
- c) Inform operating personnel of the necessary cleaning measures.

**CAUTION****Health hazard due to germ formation**

Residues may build up in the machine if not used for a long time.

- a) Clean the machine if it is not used for extended periods (more than 2 days).

**CAUTION****Formation of mold**

Mold can form on the coffee grounds.

- a) Empty and clean the grounds container at least once a day.

**NOTICE****Risk of damage to the coffee machine**





If the spout cleaning device is placed on the drip grid too soon, the dispensing spout will move toward the spout cleaning device. This may damage the coffee machine and/or the spout cleaning device.

- a) Only place the spout cleaning device on the drip grid when prompted to do so, and only once the dispensing spout has been fully lowered.

2 EXPLANATION OF SYMBOLS



2.1 Symbols used in the manual

2.1.1 Orientation

Symbol	Description
	Clean components using the 5-step method.
	This symbol indicates tips, tricks and additional information
	Prerequisites for additional steps
	Result or intermediate result for additional steps

2.2 Symbols used in the software



2.2.1 Symbols used for navigation and operation

















Symbol	Designation	Description
	Cancel button	Cancel preparation
	Select next/previous page	Scroll through menus with multiple pages
	Start button	Start preparation









2.2.2 Symbols on the dashboard and on the user interface



When a symbol is illuminated on the dashboard, additional information and instructions can be displayed by tapping the symbol. If an error occurs, refer to the **Troubleshooting [80]** chapter for help.

Symbol	Designation	Description
	Franke logo	Call up the maintenance level
	Bean left/right	Active grinder
	Double product	Produce double beverage quantity (double production)

Symbol	Designation	Description
	Ground coffee	
	Energy-saving mode	Switch the machine into energy-saving mode
	Servicing/cleaning	Machine must be cleaned and/or serviced
	Rinse	Machine must be rinsed or machine is rinsing
	Milk system cleaning agent	Milk system cleaning agent is empty (CleanMaster)
	Grounds container	Grounds container must be emptied
	Door	The door is open
	Payment	Payment active
	First Shot	Preheat system
	Service/configuration/administration	
	Brightness	Set brightness
	Individualization	Customize beverages and display
	Screen saver	
	Advertising images	
	Favorites	Favorites button, can be assigned to a function that is used frequently
	Product	
	Coffee bean	Bean hopper is empty or not installed correctly

Symbol	Designation	Description
	Milk	Milk container is empty or not installed correctly
	Cold milk	
	Powder resource	Powder hopper is empty or not installed correctly
	Info	
	Event log	List of event and error messages
	Individual products counter	
	Inactive	
	Data transfer	Data is being transferred

2.2.3 Depiction of error messages





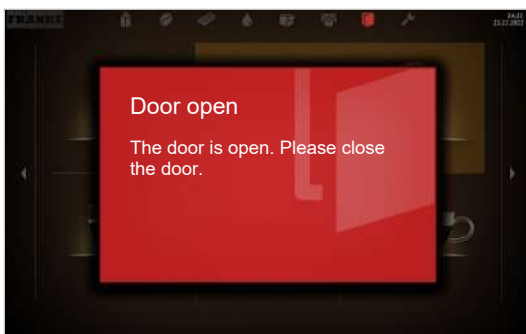

Highlighted products cannot be prepared. The illuminated symbol on the dashboard takes you to the error message.



If the entire system is affected by an error, the error message will appear automatically.













Color code for error messages





-  Temporary interruption
 -  System still fully functional
 -  System has limited functionality
 -  Some or all resources are locked
-

3 SCOPE OF DELIVERY



The scope of delivery may vary, depending on the configuration of the appliance. Additional accessories may be obtained directly from your retailer or from Franke Kaffeemaschinen AG in Aarburg, Switzerland.

	Item description	Item number
	Coffee machine A1000 (FCS4059)	
	Manual set	560.0001.833 / 560.0001.801
	Cleaning tablets (100 pcs.)	567.0000.010
	Cleaning tablets (China)	567.0000.016
	Cleaning tablets (USA/Canada)	567.0000.002
	Milk system cleaning agent (cartridge)	567.0000.009
	Milk system cleaning agent (cartridge) (USA/Canada/Mexico)	567.0000.004
	Measuring cup 1000ml	560.0002.653
	Spout cleaning device (Self-Serve Package option only)	560.0604.024
	Wire basket (option for SU12/UT12 FM CM) (USA)	560.0651.743
	Cleaning brushes	560.0003.728
	Hose brush (option FM/MS)	560.0007.380
	Paint brush	560.0003.716
	Microfiber cloth	560.0002.315

	Item description	Item number
	Grinder adjustment wrench	560.0003.876
	Aerator/hose wrench	560.0522.696
	Drip grid extension	560.0484.609
	Drip grid extension (option single-piece drip grid extension (USA))	560.0574.078

4 IDENTIFICATION

4.1 Position of type plates

4.1.1 Coffee machine

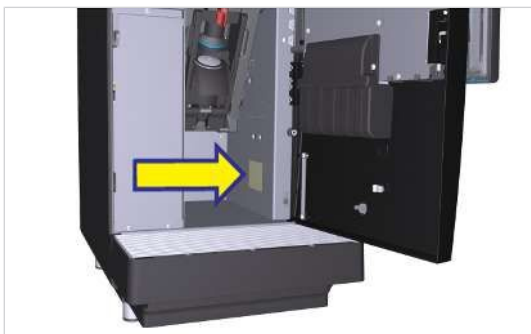

The type plate for the coffee machine is located on the right interior wall.

4.1.2 Cooling unit SU12/UT12



The type plate for the cooling unit is located on the left-hand side in the cooling chamber.

4.1.3 Flavor Station FS



The type plate for the FS Flavor Station is located in the interior on the rear panel.

4.1.4 Under-counter Flavor Station FSU



The type plate of the under-counter Flavor Station (FSU) is located on top of the left-hand side of the housing.

4.1.5 CW (option)



The type plate for the cup warmer is located in the interior on the rear panel.

4.1.6 AC200 (Option)



The type plate of the AC200 is located on the left-hand side of the pullout.

4.1.7 MU FM EC

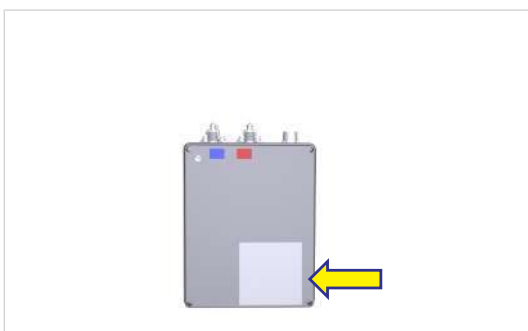

The type plate for the milk pump module (MU) is located at the bottom on the right side of the casing.

4.2 Type code

4.2.1 Coffee machine

Type code	Description
A1000	Coffee machine (fully automatic) Product line: A Overall size: 1000
1G	1 grinder
2G	2 grinders
3G	3 Grinders
1P	1 powder dosing unit
2P	2 powder dosing units
CM	CleanMaster
H1	Left-hand hot water spout
H2	Hot water spout center
FM	FoamMaster (cold and warm milk, cold and warm milk foam)
S1	Steam wand
S2	Autosteam (steam wand with temperature sensor)
S3	Autosteam Pro (steam wand with temperature sensor and programmable milk foam consistency)
1IC	Iced Coffee Module

4.2.2 Add-on units

Type code	Description
SU12	Cooling unit (12 l or 2 x 4.5 l) right next to the coffee machine
UT12	Under-counter cooling unit (12 l or 2 x 4.5 l)
MU	Milk pump module
FS60	Flavor Station with 6 flavor pumps
FSU60	Under-counter Flavor Station with 6 flavor pumps
CW	Cup warmer
FM	FoamMaster (cold and warm milk, cold and warm milk foam)
CM	CleanMaster
Twin	Modified cooling unit for the simultaneous use with two coffee machines
AC	Accounting system
CC	Coin changer
CL	Cashless
CV	Coin validator

5 DESCRIPTION OF MACHINE

5.1 Coffee machine

The A1000 coffee machine is available with numerous options. To provide you with an overview of your machine, a sample configuration is illustrated here. Please note that your coffee machine may look different from the configuration shown here.



5.1.1 Standard

- 10.4" touch screen
- One grinder (rear LH)
- Hot water spout
- Spout with automatic height adjustment
- iQFlow™
- CleanMaster
- Feet, 40 mm
- Main water connection
- Support for video files

5.1.2 Options

- Premium version
- Second grinder (rear RH)
- Second grinder (left, front and rear)
- Third grinder
- Powder hopper
- Second powder hopper (front RH)
- Iced Coffee Module (right-front)
- Steam wand
- Autosteam (steam wand with temperature sensor)
- Autosteam Pro (steam wand with temperature sensor and programmable milk foam consistency)
- Two milk types
- Grounds ejection
- Spout for jug
- Lockable bean and powder hopper
- Cup sensor
- Optical Cup Recognition
- First Shot
- Feet, 7 mm
- Adjustable feet, 70 mm
- Adjustable feet, 100 mm
- TDS sensor
- Touchpad as accessibility feature for wheelchair users
- Tank kit (not in conjunction with Iced Coffee Module)
- Franke Digital Services

Iced Coffee Module



- The Iced Coffee Module is located at the front right-hand side of the coffee machine.
- The Iced Coffee Module actively cools the freshly brewed coffee to below 40 °C.
- The module is available as an option and cannot be retrofitted.
- The Iced Coffee Module is cleaned as part of the existing coffee machine cleaning process. This means that no additional manual cleaning work is required, and there is no need for a separate cleaner.



The Iced Coffee Module opens up plenty of possibilities with regard to the beverages you can make, e.g., Iced Espresso, Iced Coffees and Iced Americano. These beverages can also be combined with milk, milk foam and/or syrup.

5.1.3 Coffee machine components

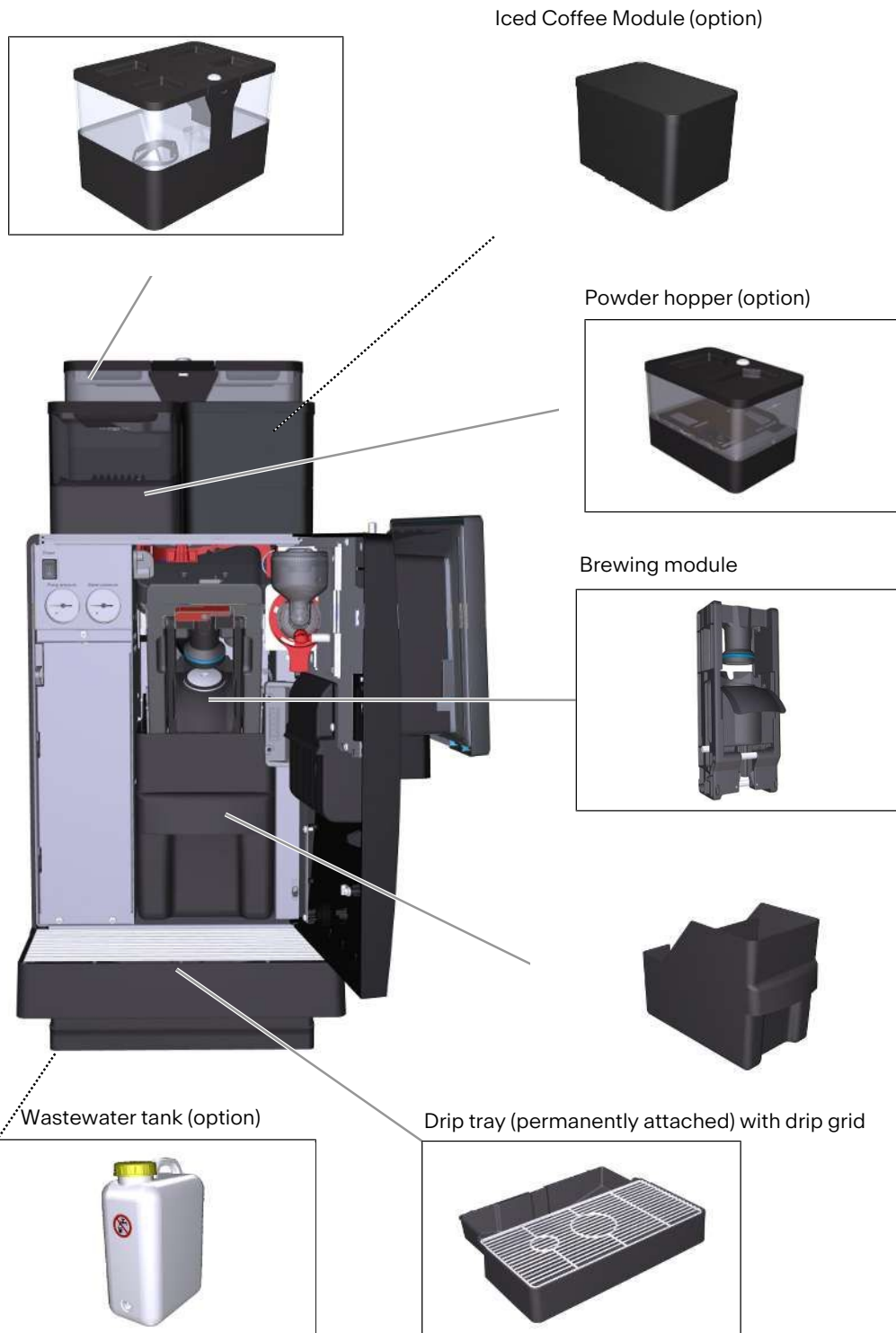

5.2 Add-on units

5.2.1 Cooling unit



SU12

The cooling unit ensures that up to two milk types stay chilled until you're ready to make the perfect cup. The unit is simple to refill and even easier to clean, so your customers experience pure coffee enjoyment.

The cooling unit is available with different features and configurations.

Features

- Semi-automatic or automatic cleaning system (depending on the version)
- With IndividualMilk Technology (for 1OM/2OM versions)
- Left-hand and right-hand connection to the machine possible
- Lockable

Versions

- SU12 with 12 l milk container
- SU12 with 2 x 4.5 l milk containers for the use of 2 milk types
- SU12 FM CM 2OM with 2 x 4.5 l medium containers for keeping 2 milk types (milk and milk beverage) or 1 milk type and an additional medium (e.g., Cold Brew) separate all the way to the cup
- SU12 Twin with 2 x 4.5 l milk containers for connecting 2 coffee machines
- UT12 FM under-counter cooling unit with 12 l milk container
- UT12 FM Twin under-counter cooling unit with 2 x 4.5 l milk containers for connecting 2 coffee machines

5.2.2 Flavor Station



FS/FSU EC

Our Flavor Station is available to you as an option for extraordinary beverage creations. You can use the Flavor Station to extend your range of beverages with up to six different flavors.

5.2.3 Cup warmer



To enjoy coffee at its best, you need pre-heated cups. The cup warmer with four heatable shelves fits perfectly to your coffee machine.

5.2.4 Accounting system



The accounting system processes all payment transactions and records all accounting data.

Interfaces:

- VIP

Payment systems:

- Coin validator
- Coin changer
- Card readers

5.2.5 Pump module MU FM EC



The pump module is designed for use in third-party refrigerators. The module conveys the milk used for the preparation of beverages to the Franke coffee machine.

MU FM EC

5.3 Overview of operating modes



The suitable operating mode depends on the utilization of your coffee machine, your product range and the preferences of your customers.

Your service technician will be happy to help you set the appropriate operating mode.

5.3.1 User interface



1 Use the Franke logo to switch between the maintenance level and product selection

2 Scroll forwards or backwards

5.3.2 Cash Register operating mode



Cash Register is the operating mode for non-self-service utilization. You can add additional orders while your coffee machine is preparing a product.

Structure of the user interface

- Level 1: Product selection, up to 5 pages. Column with the possible options, the production status, and the waiting list
- Level 2: Display of 4, 9, or 16 product buttons per page

Individual adaptations

- Display: 2x2, 3x3, or 4x4 products per page
- Depiction: Photo-realistic, drawn

5.3.3 Quick Select operating mode



The Quick Select operating mode is the standard setting for self-service. Once your customer has selected a beverage, he/she can adapt it in the second step if product options are activated.

Structure of the user interface

- Level 1: Product selection, up to 5 pages; 6, 12 or 20 product buttons can be displayed per page
- Level 2: Customize beverages, select product options, initiate beverages preparation process

Individual adaptations

- Display: 2x3, 3x4 or 4x5 products per page
- Activate Credit Mode
- Individual arrangement of beverages

5.3.4 Operating modes in combination with Credit Mode



The Credit Mode works with every operating mode and makes the product prices, credit and lack of credit clear on the operator panel.



In the Drink Selection status, you cannot add any drink options with the Credit Mode configuration. You can activate the Credit Mode in the My settings menu under 1 Set machine > 1.12 Payment. Select Activate payment.



Display

- Product prices
- Credit
- Missing credit

Menu item 1.12 Accounting [62]

5.4 Franke Digital Services (option)

Developed specially for the Franke coffee machine fleet, our digital services give you control and a clear overview of all activities and information about the coffee machines. Centrally controlled remote maintenance, such as software and configuration updates, means that on-site interventions are not required.

You can obtain additional information from your Franke service technician or on the Franke website.

6 INSTALLATION

6.1 Preparations

- The main power connection for the coffee machine must be protected by a residual current circuit-breaker (RCCB).
- Each terminal of the power supply must be able to be interrupted using a switch.
- The water connection must comply with *Requirements of the water supply [31]* and local and national rules and regulations.
- The coffee machine must be connected to the water supply with the supplied hose kit. Do not use any other water hoses that happen to be present.
- Ensure that the coffee machine can be placed on a horizontal and stable support with a load capacity of min. 150 kg. The operator panel should be at eye level and allow ergonomic operation.



You must have completed these preparations before a service technician can install the coffee machine for you. The service technician will install your coffee machine and carry out the initial commissioning process. The technician will walk you through the basic functions.

6.2 Dimensions



All dimensions are specified in mm.

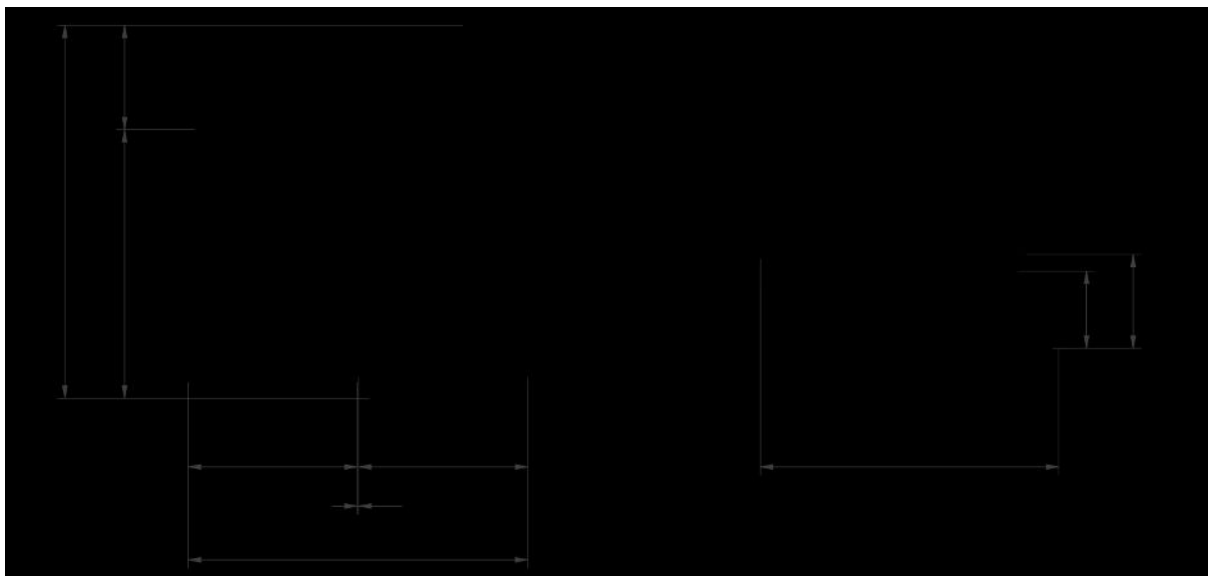

Front/side view

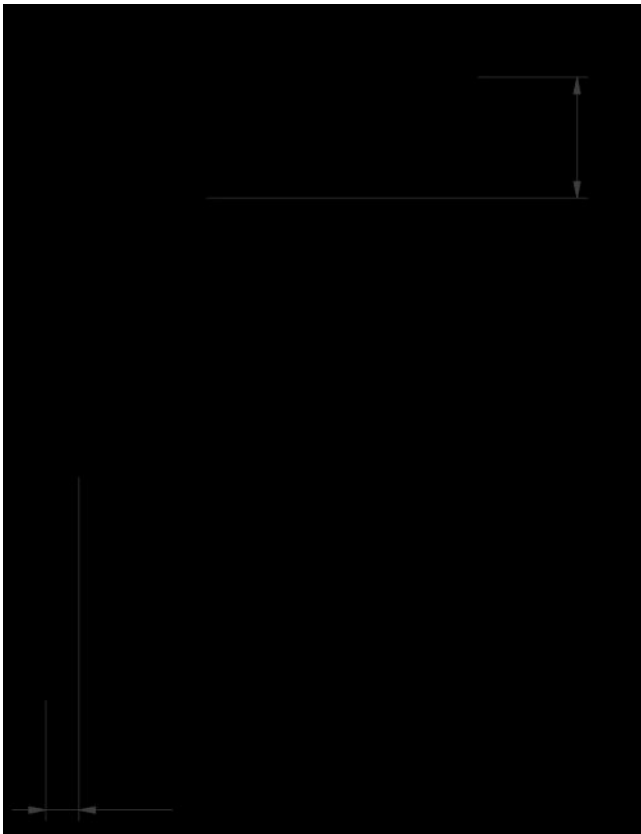

Minimum distances, top and rear

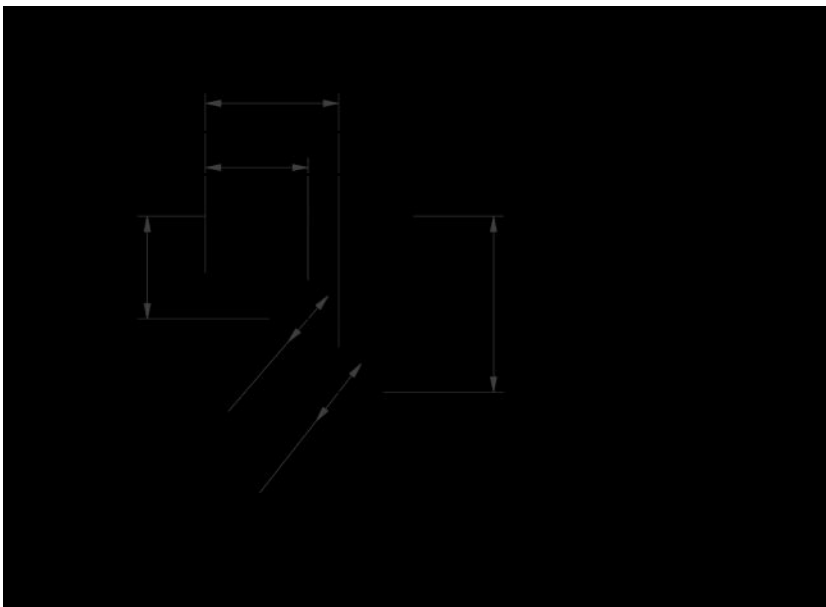

Hose feedthrough in the counter

Minimum clearances

- To the rear panel: 50 mm
- Above: 200 mm (for filling and removal of the bean hopper)
- To the right: 100 mm (for opening the door)



NOTICE

Overheating damage

If the clearances around and above the machine are too small, heat may accumulate in the machine and lead to faults.

- a) Maintain the prescribed installation dimensions and clearances.
- b) Take care to ensure that the clearance spaces are not blocked.

6.2.1 Feet

A1000 is delivered with feet.

- Feet 40 mm (standard)
- Feet 7 mm (option)
- Feet 70 mm (option)
- Feet 100 mm (option)

Adjustable feet can be used to compensate for unevenness or differences in height.

6.3 Requirements of the water supply

6.3.1 Main water connection

Water pressure	0,8-8,0 bar
Flow rate	>100 ml/s
Water temperature	<25 °C
Connection to the main water connection	G3/8" compression fitting and metal hose l = 1500 mm
	Only connect with the hose kit provided

- The main water connection must meet the requirements of the technical data and comply with applicable federal, state, and local regulations.
- The main water connection must have a backflow prevention device.
- The main water connection must be equipped with a shut-off valve and a check valve with an upstream filter accessible for inspection. It must be possible for the filter to be removed for cleaning.
- Water from the household decalcification system must not be used.
- Filter with at least 100 loops/inch (UL)

6.3.2 Water quality

Total hardness:	4–8° dH GH (German total hardness)
	7–14° fH GH (French total hardness)
	4,2–8,3 GPG
	70–140 ppm (mg/l)
Carbonate hardness	3–6° dH KH / 50–105 ppm (mg/l)
Acid content/pH value	6.5–7.5 pH
Chlorine content	< 0.5 mg/l

Chloride content	< 30 mg/l
TDS (total desolved solids)	30–150 ppm (mg/l)
Electrical conductivity (measured)	50–200 $\mu\text{S/cm}$ (microsiemens)
Iron content	< 0.3 mg/l

- Color: Clear
- Taste: Fresh and pure taste
- Aroma: No perceptible aroma
- No rust particles in the water
- Reverse osmosis: The water must have a dissolved solids content of at least 30-50 ppm (30-50 mg/l) in order to prevent the boiler being overfilled.

Evaluating the risk of corrosion

The following formula can be used for evaluation:

Calculated conductivity = measured conductivity [$\mu\text{S/cm}$] – (measured total hardness [dH GH] x constant)

- Measured conductivity in $\mu\text{S/cm}$
- Measured total hardness in dH GH
- Constant = $30 [\mu\text{S/cm}]/[\text{dH GH}]$

Calculated conductivity	Risk of corrosion
<200 $\mu\text{S/cm}$	low
200 – 500 $\mu\text{S/cm}$	increased
>500 $\mu\text{S/cm}$	high

Calculation example:

- Measured conductivity 700 $\mu\text{S/cm}$
- Measured total hardness 18 dH GH
- Calculated conductivity = $700 \mu\text{S/cm} - (18 \times 30 \mu\text{S/cm}) = 160 \mu\text{S/cm}$

The result of the calculation is 160 $\mu\text{S/cm}$ and means that there is a low risk of corrosion.

6.3.3 Water outlet

- Drain hose: D = 20 mm, L = 2000 mm
- Connection to a lower-lying siphon

7 FILLING AND EMPTYING

7.1 filling the machine



NOTICE

Incorrect filling of the hoppers

Incorrectly filling the hoppers can produce defective products and the machine can be damaged as a result.

- a) Fill the bean hopper with coffee beans.
- b) Fill the powder hopper with powder suitable for automatic coffee makers.

7.2 Filling beans



WARNING

Risk of injury

If objects find their way into the bean hopper or grinder, splinters may be ejected, leading to injury.

- a) Never insert any objects into the bean hopper or grinder.



NOTICE

Poor beverage quality

The oil from the coffee beans is deposited on the inside of the bean hopper as a thin film of oil. This deposited oil ages quickly and impairs the taste of the beverages produced.

- a) Remove the oil film from the inside of the bean hopper on a daily basis.
- b) To do this, use a dry cloth or a cloth moistened only with water.
- c) Do not use any cleaners, as these alter the taste of the coffee.



1. Lift off the bean hopper lid.



2. Fill coffee beans.



3. Fit the lid.

7.3 Filling powder



1. Lift off the powder hopper lid.



3. Fit the lid.



2. Fill with powder suitable for automatic beverage dispensers.

7.4 Filling the cooling unit



CAUTION

Germs in unpasteurized milk

Germs in unpasteurized milk could pose a health hazard.

- a) Do not use any unpasteurized milk.
- b) Only use pasteurized or long-life milk.



NOTICE

Machine damage

Using incorrect liquids can damage the machine.

- a) Only fill the milk container with milk.
- b) Use water and a mild cleaner to clean the milk container.



NOTICE

Spoiled milk

Insufficient cooling or hygiene can cause milk to spoil.

- a) Only use precooled milk (2-5 °C).
- b) Only store milk in the cooling unit during operating hours. Outside operating hours, e.g. overnight, store the milk in a refrigerator.
- c) Clean the machine and cooling unit once a day.
- d) Only touch the suction hose, the inside of the milk container, and the milk container lid after sanitizing your hands, or when wearing single use gloves.
- e) Place the container lid with the suction hose on a clean surface only.



The milk system is prepared semi-automatically after a cleaning or a filling procedure. Please observe the instructions in the event messages. Access to the event messages is through the dashboard.

7.4.1 Cooling unit SU12/UT12

NOTICE! This cooling unit is available in several versions and may therefore differ from the following illustrations depending on the configuration.

1. Open the door.



2. Switch the cooling unit on.

⇒ The current cooling chamber temperature is displayed.



3. Only pull out the milk container until the point where the sliding cover of the container lid is fully visible.



4. Push the sliding cover backwards.

5. Fill the milk container with cooled milk.



6. Close the sliding cover.



7. Push the milk container all the way into the cooling chamber.



8. Close the door.

7.5 Filling refrigerator (with pump module (MU))



NOTICE

Machine damage

Using incorrect liquids can damage the machine.

- a) Only fill the milk container with milk.
- b) Use water and a mild cleaner to clean the milk container.



NOTICE

Spoiled milk

Insufficient cooling or hygiene can cause milk to spoil.

- a) Fill the milk only into clean containers.
- b) Only touch the suction hose, the inside of the container, and the container lid after sanitizing your hands, or wear single use gloves.
- c) Place the container lid with the suction hose on a clean surface only.



The following illustrations show an example refrigerator. The actual design may differ.



1. Open the door.
2. Turn on the refrigerator if necessary.

4. Fill the milk container with cooled milk.



5. Slide the milk container into the refrigerator.



3. Pull out the milk container and remove the container lid.



6. Close the door.

7.6 Filling the Flavor Station



The on/off switch of the Flavor Station FS is located inside, on the left-hand side of the rear panel.

1. Use the key to unlock the Flavor Station.



2. Press the unlocking button and open the Flavor Station.



3. Switch on the Flavor Station.



4. Lift the bottle holders.
5. Place the bottles in the Flavor Station.



6. Pull the bottle holders down.

7. Push the hose connection on the hose upwards.



8. Insert the hose into the bottle.
 9. Push the hose connection into the top of the bottle.
 10. Close the Flavor Station.
 11. Confirm Prepare Flavor Station on the display.
- ⇒ The hoses of the Flavor Station are pre-filled with syrup.

7.7 Setting the grind coarseness



WARNING

Risk of injury

If objects find their way into the bean hopper or grinder, splinters may be ejected, leading to injury.

- a) Never insert any objects into the bean hopper or grinder.



Grinder adjustment wrench (560.0003.876)



Changing the grind coarseness affects the amount of ground coffee and therefore the quality of the beverage. We recommend having a qualified service technician change the grind coarseness and calibrate the grinders as required.

The grind coarseness can be set in stages for every single grinder.

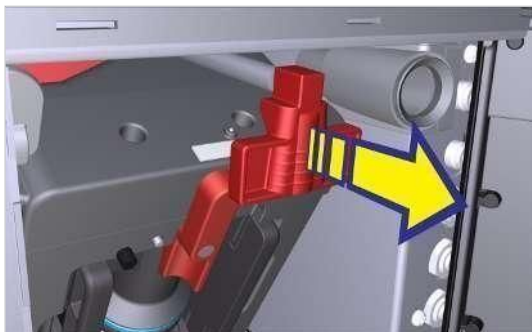

1. Pull the locking slide towards the front up to the stop.



2. Remove the bean hopper by lifting it upwards.

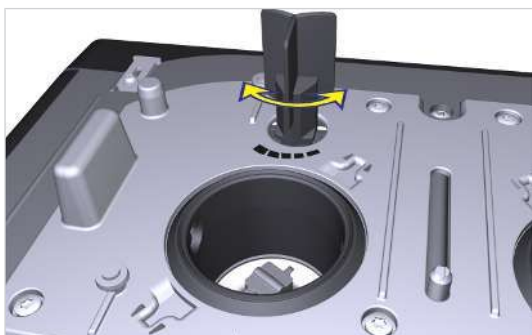

3. If necessary, adjust the grind coarseness using the grinder adjustment wrench.

⇒ Turn counterclockwise for a finer grind.

⇒ Turn clockwise for a coarser grind.

4. Check the grind produced and adjust if necessary.



5. Attach the bean hopper.

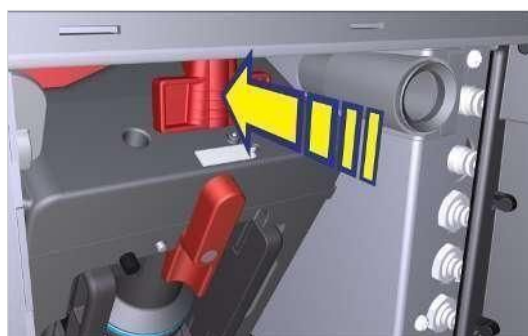

6. Push the locking slide all the way in.



NOTICE

Impairment of function

If the bean hopper and powder hopper are not locked correctly, the function of the coffee machine and the product quality may be impaired.

a) Push the locking slide all the way in.

7.8 Emptying the bean hopper

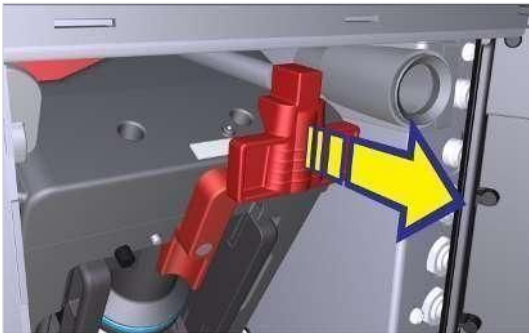

1. Pull the locking slide towards the front up to the stop.



2. Remove the bean hopper by lifting it upwards.

3. Empty, clean, and dry the bean hopper.

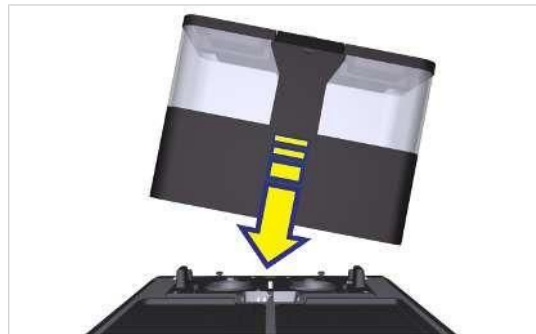

4. Attach the bean hopper.

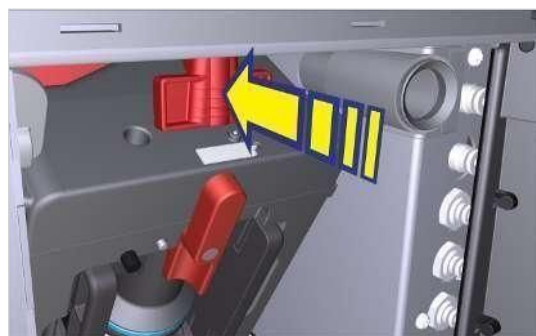

5. Push the locking slide all the way in.



NOTICE

Impairment of function

If the bean hopper and powder hopper are not locked correctly, the function of the coffee machine and the product quality may be impaired.

- a) Push the locking slide all the way in.

7.9 Emptying the powder hopper



CAUTION

Cutting injuries/crushing

The powder hoppers worm gear mechanism can cause cuts or crushing injuries.

- a) Exercise care when cleaning the powder hopper.



NOTICE

Contamination from powder

Powder can fall from the powder hopper.

- a) Always transport the powder hopper in an upright position and ensure it is closed.

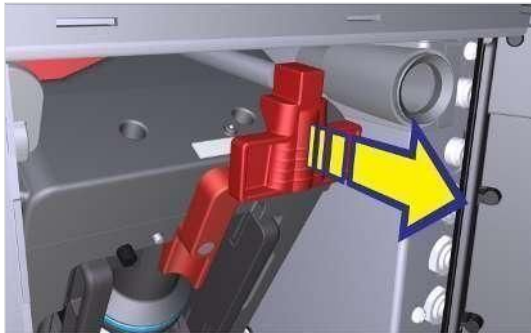

1. Pull the locking slide towards the front up to the stop.

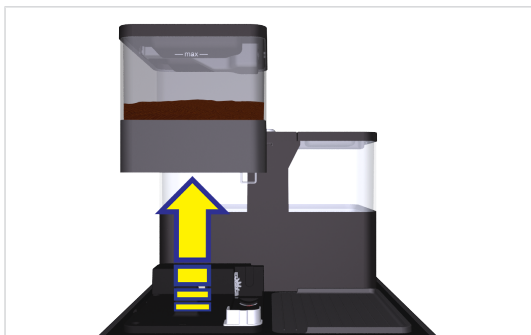

2. Lift and remove the powder hopper.

3. Empty, clean, and dry the powder hopper.

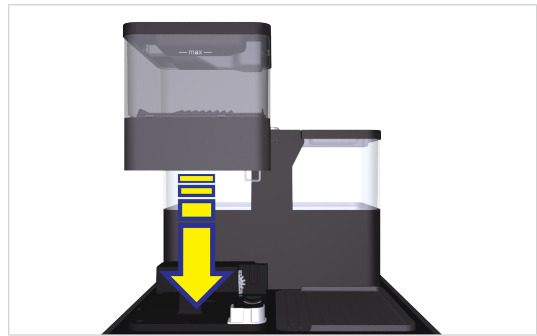

4. Attach the powder hopper.

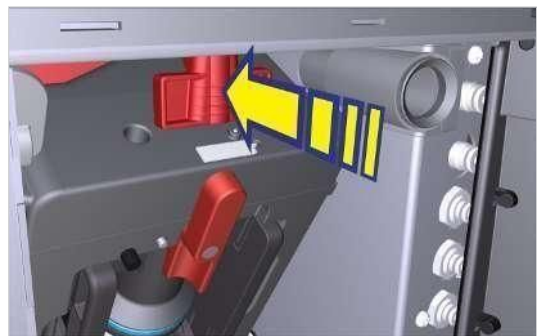

5. Push the locking slide all the way in.



NOTICE

Impairment of function

If the bean hopper and powder hopper are not locked correctly, the function of the coffee machine and the product quality may be impaired.

- a) Push the locking slide all the way in.

7.10 Emptying the grounds container



NOTICE

Formation of mold

Coffee residue can lead to the formation of mold.

- a) Empty and clean the grounds container at least once a day.

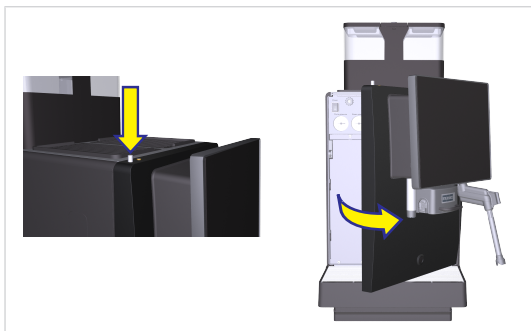

1. Open the door.

⇒ The message Door open appears on the user interface.

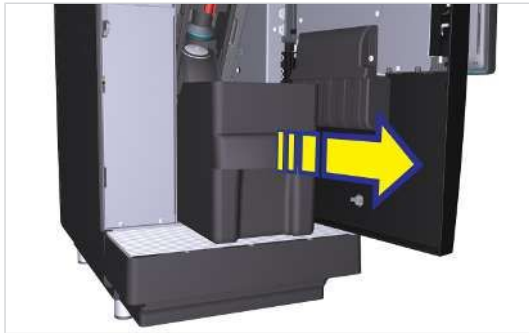

2. Remove the grounds container.



4. Insert the grounds container and close the door.



3. Empty, clean, and dry the grounds container.

7.11 Emptying the cooling unit



NOTICE

Spoiled milk

Insufficient cooling or hygiene can cause milk to spoil.

- a) Only use precooled milk (2-5 °C).
- b) Only store milk in the cooling unit during operating hours. Outside operating hours, e.g. overnight, store the milk in a refrigerator.
- c) Clean the machine and cooling unit once a day.
- d) Only touch the suction hose, the inside of the milk container, and the milk container lid after sanitizing your hands, or when wearing single use gloves.
- e) Place the container lid with the suction hose on a clean surface only.



NOTICE

Blockage of the milk system

Fibers from unsuitable cleaning cloths can enter the milk/media system and cause a blockage. This can damage the machine.

- a) Use a microfiber cloth to clean the milk container.

7.11.1 Cooling unit SU12/UT12

NOTICE! This cooling unit is available in several versions and may therefore differ from the following illustrations depending on the configuration.

1. Open the door.



2. Pull out the milk container.
3. Keep the milk in a refrigerator, or dispose of it if necessary.
4. Clean the milk container, milk container lid, reversible adapter, push-in connections, suction hoses, and cooling chamber.



6. Switch the cooling unit off if it is no longer required.



5. Insert the cleaned milk container.



7. Leave the door of the switched-off cooling unit slightly open to prevent odors from building up inside.

7.12 Emptying the refrigerator (with pump module (MU))



NOTICE

Blockage of the milk system

Fibers from unsuitable cleaning cloths can enter the milk/media system and cause a blockage. This can damage the machine.

- a) Use a microfiber cloth to clean the milk container.



The following illustrations show an example refrigerator. The actual design may differ.



1. Open the door.



2. Pull out the milk container.

3. Clean the milk containers, milk container lids, push-in connections, suction hoses and the cooling chamber.
4. Insert the cleaned milk containers, milk container lids, push-in connections and suction hoses.
5. Switch off the refrigerator if it is no longer required.



6. Leave the door of the switched-off refrigerator slightly open to prevent odors from building up inside.

7.13 Emptying the Flavor Station

1. Clean the Flavor Station. See **Start cleaning** [50].

2. **NOTICE! After cleaning, do not insert the hoses back into the bottles.** Remove the bottles from the Flavor Station.
3. Close the Flavor Station.

8 PREPARING BEVERAGES



WARNING

Risk of scalding

Hot beverages can lead to scalding.

- a) Always be careful with hot beverages.
- b) Use only suitable drinking vessels.

8.1 Preparing beverages with Quick Select

1. Place an appropriate drinking vessel under the dispensing spout.



2. Select a product.

⇒ The product preview will appear.

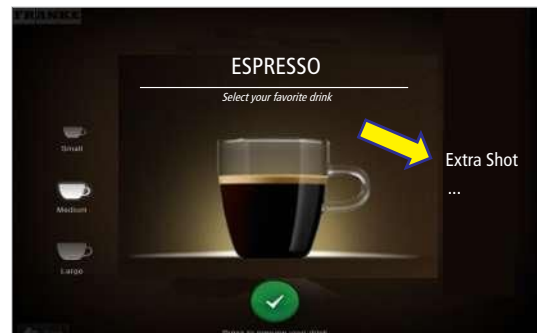

3. Select product options.

4. Press the green button to start preparation.

⇒ The beverage is being prepared.



⇒ The product selection screen appears when the product is ready.

8.2 Preparing beverages with Cash Register



When preparing several products one after the other, please observe the following:

- a) Have sufficient drinking vessels ready to use.
- b) You can continuously add new products to the waiting list during the preparation.
- c) You can select and clear products from the waiting list.

1. Place an appropriate drinking vessel under the dispensing spout.



2. Select the product options.



4. Add more products to the queue list as needed.



3. Select a product.

⇒ The preparation begins.



5. Start the preparation of each of the products in the queue list by pressing the green button.

⇒ The next preparation begins.

⇒ The product selection appears.

⇒ All products are ready.

8.3 Preparing beverages with ground coffee



Only ground coffee may be used. Instant coffee made from dried coffee extract cannot be used.

1. Place an appropriate drinking vessel under the dispensing spout.



2. Press the Decaffeinated coffee selection button.



⇒ The Decaffeinated coffee selection button illuminates.

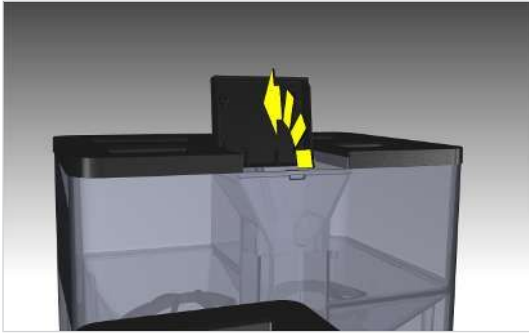

3. Open the insertion flap.
4. Fill powder.

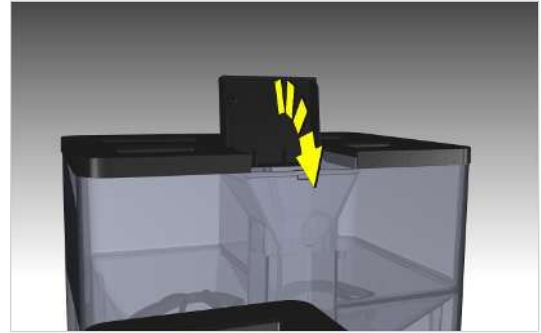

5. Close the insertion flap.
6. Confirm the message by pressing OK.
 - ⇒ The preparation begins.
 - ⇒ The product selection appears.
 - ⇒ The product is ready.

8.4 Preparing hot water



You can stop the hot water spout at any time by pressing the cancel button.

Example: Quick Select



1. Place an appropriate drinking vessel under the hot water spout.



3. Select the cup size.
 - ⇒ Hot water is dispensed until the cycle is complete.

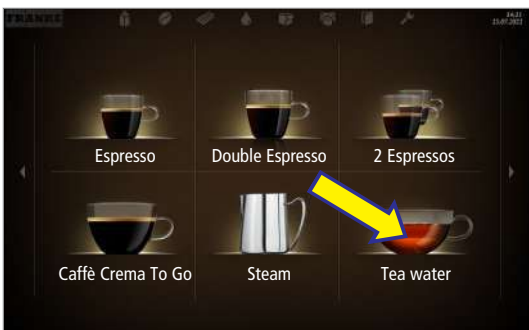

2. Select Tea water.

8.5 Steam dispenser (Autosteam/Autosteam Pro)



Autosteam is suitable for manually heating and foaming/frothing of milk and for heating other drinks.



Using the purging function will remove any condensation from inside the steam wand.

1. Press the purge button  .
2. Place a milk pitcher under the steam wand.

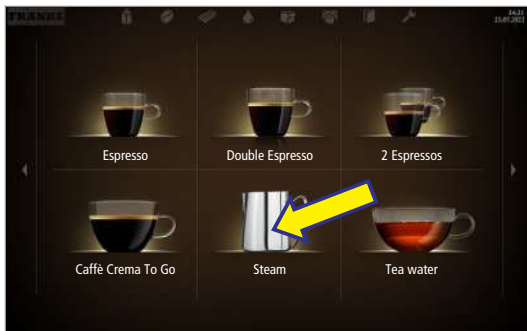

3. Select steam output.
 - ⇒ The wand will start producing steam.
 - ⇒ Steam output will automatically stop when your beverage has reached the specified temperature.

⇒ The beverage overview screen appears.



4. If required, press the cancel button to stop the steam output.

5. Press the purge button  and wipe the steam wand with a damp cloth.

8.6 Preparing beverages using the touchpad



The touchpad is an accessibility feature for wheelchair users.

1. Place an appropriate drinking vessel under the dispensing spout.



2. Use the touchpad to move the cursor to the required place on the screen.

3. Tap on the touchpad once.

⇒ The coffee machine performs the chosen action.

9 CLEANING

9.1 Introduction

The perfect coffee experience depends on a perfectly cleaned coffee machine, cooling unit and Flavor Station (option). Increase your product quality! Clean your coffee machine and add-on units at least once a day and more frequently if necessary.

The automatic cleaning process involves cleaning the coffee, cooling unit and Flavor Station (if applicable).



NOTICE

Dirty components

Dirty components can have a negative effect on the function of the machine and the quality of beverages.

a) Clean the removable components using the 5-step method.



The removable components of the coffee machine, cooling unit, CleanMaster and Flavor Station (optional) are not dishwasher-safe.



Rinsing is not a substitute for daily cleaning! Rinsing is necessary to remove residue build-up in the coffee and milk systems.

The machine automatically rinses after certain time intervals as well as when it is switched on or off.

9.2 Required cleaning accessories

- Cleaning tablets
- Microfiber cloth
- Paint brush
- Brush set
- Spout cleaning device (if the hot water also comes from the central spout)
- Paper towel (for all-in-one spout)

9.3 5-step method



Clean the removable components of your coffee machine using the 5-step method. The display shows you the components that can be removed during cleaning.

Clean the container and accessories of the cooling unit

Clean the containers and accessories, such as the lid, suction hose, suction nozzle, etc. using the 5-step method.

1. Remove coarse dirt with a cleaning brush or paint brush.
2. Soak the components in hot water with a mild cleaner.
3. Wash the components.
4. Rinse the components thoroughly.
5. Dry the components.

Additional areas to be cleaned by hand

- Inner side of the door and door gasket on cooling unit
- Inner surfaces and shelf (if applicable) in the cooling chamber

- Interior, pullout and bottle holders (if applicable) of the Flavor Station

9.4 Starting the cleaning process



When the cleaning cycle is complete, the machine either switches back to the maintenance level or the energy saving mode. Your service technician can set the desired option for you.

9.4.1 Starting cleaning via the Cleaning and Maintenance menu



WARNING

Risk of scalding

Hot liquids and steam escape during cleaning and can lead to scalding.

- Keep hands away from the spouts and nozzles during this process.

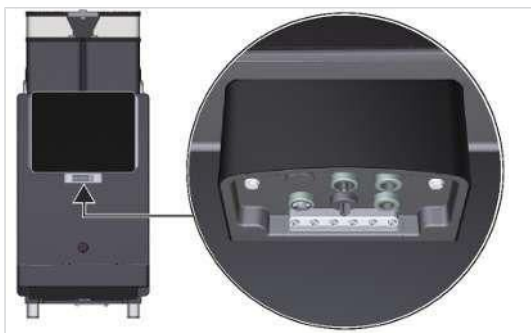

- If equipped with an all-in-one spout, remove any contamination from the dispensing nozzles using a brush before starting the automatic cleaning process.



- Tap the Franke logo.



- Enter the PIN. **PIN codes [56]**
- Press Ok.

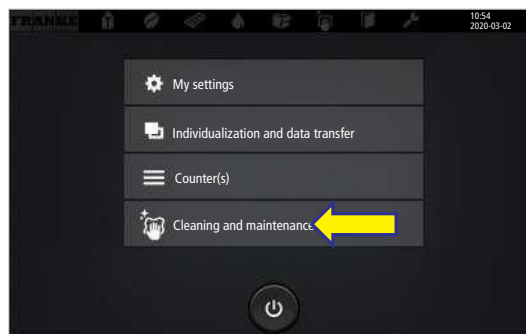

- Select Cleaning and maintenance.

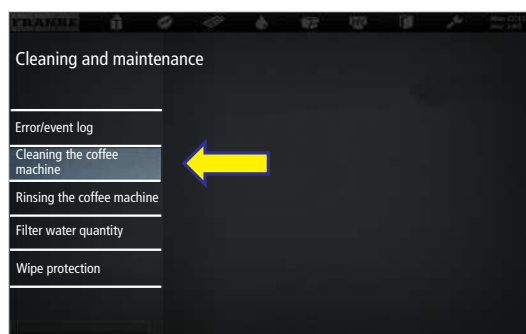

- Select Clean coffee machine.

7. Confirm message with Yes to begin the cleaning process.
 8. Follow the instructions on the user interface and confirm the completed steps by selecting Next.
- ⇒ The machine shows the next step.



9. After completing the automatic cleaning process, wipe the all-in-one spout with a paper towel.

9.4.2 Start cleaning for cooling unit SU12 CM

1. Open the door.



2. Pull the milk container forwards.



3. Pull the reversible adapter upwards and from the suction fitting.
4. Turn the reversible adapter 180°.
5. Place the reversible adapter onto the suction fitting.



6. Slide the milk container all the way in.



7. Set the switch to the cleaning position.

⇒ The machine switches automatically to the cleaning mode.



8. Close the door.

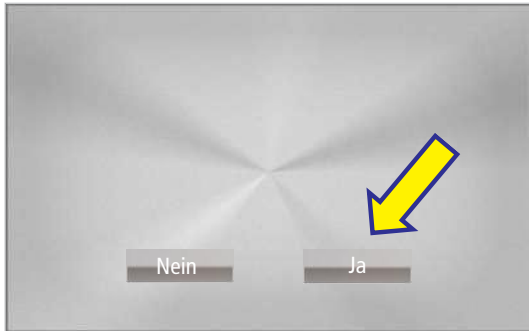

9. Start the cleaning process by selecting Yes on the operator panel.
10. Follow the instructions on the user interface and confirm by pressing Next.
 - ⇒ The machine guides you to the next step.



WARNING

Risk of scalding

Hot liquids and steam escape during cleaning and can lead to scalding.

- a) Keep hands away from the spouts and nozzles during this process.

9.5 Cleaning the aerator



1. Remove the aerator for hot water with the tool and descale.

2. Screw the aerator back in.

9.6 Weekly cleaning



Clean the machine components listed in this chapter at least once a week, in addition to the daily cleaning process. Clean the machine immediately if you notice any soiling.

9.6.1 Cleaning the machine surface

1. Clean the surface of the machine with a damp cloth.
2. If necessary, use a mild cleaner. **NOTICE! Do not use abrasive cleaners.**

9.6.2 Cleaning the bean hopper and powder hopper



CAUTION

Formation of mold

Moisture within the bean hopper may lead to the growth of mildew.

- a) Do not bring the bean hopper into direct contact with water.
- b) Use only a damp cloth for cleaning.
- c) Ensure that the bean hopper is completely dry before attaching it.



CAUTION

Cutting injuries/crushing

The powder hoppers worm gear mechanism can cause cuts or crushing injuries.

- a) Exercise care when cleaning the powder hopper.

- ✓ Use a dry cloth or one that has been moistened with water only.
- ✓ Do not use any cleaners, as these alter the taste of the coffee.

1. Open the door.

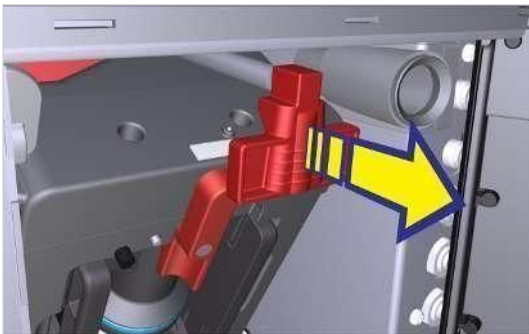

2. Pull the locking slide towards the front up to the stop.



3. Remove the bean hopper and powder hopper (if applicable).
4. Empty the bean hopper and powder hopper (if present).

5. Remove the oil film on the inside of the bean hopper using a cloth.

6. Clean the powder hopper with a damp cloth. Wipe the inside of the hopper with a dry cloth.

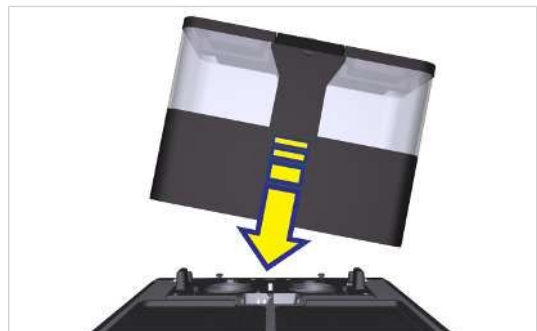

7. Attach the bean hopper and powder hopper (if applicable).

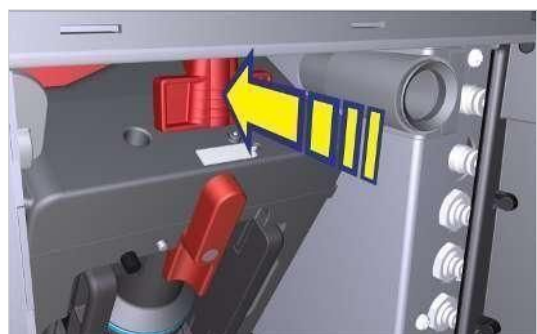

8. Push the locking slide all the way in.

9. Close the door.

9.6.3 Cleaning the screen



1. Tap the Franke logo.

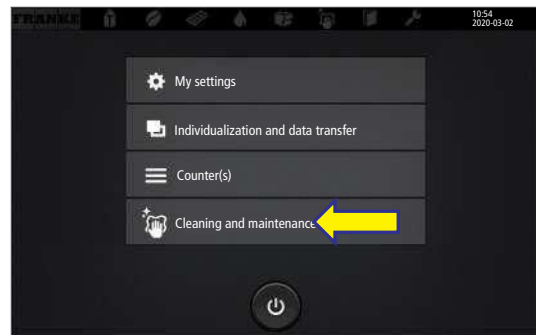

4. Select Cleaning and maintenance.



2. Enter the PIN. *PIN codes [56]*

3. Press Ok.

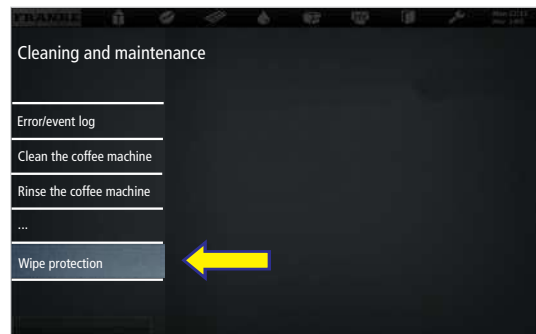

5. Select Wipe protection.

⇒ The user interface is locked for 20 seconds.

6. Clean the screen.

⇒ The maintenance level appears.

9.7 Rinsing the coffee machine



WARNING

Risk of scalding

Hot water is released during rinsing.

- Keep hands away from the spouts and nozzles during this process.
- Do not place anything on the drip grid.
- IN CASE OF SCALDING: Immediately cool the affected area and, depending on the severity of the injury, consult a doctor.



Rinsing is not a substitute for daily cleaning! Rinsing is necessary to remove residue build-up in the coffee and milk systems.

The machine automatically rinses after certain time intervals as well as when it is switched on or off.



1. Tap the Franke logo.

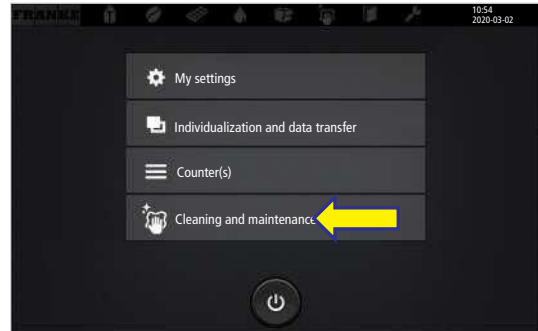

4. Select Cleaning and maintenance.



2. Enter the PIN. **PIN codes [] 56]**

3. Press Ok.

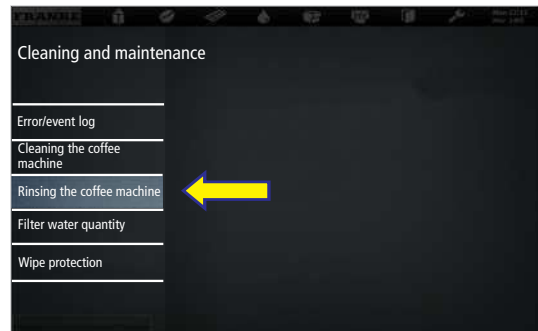

5. Tap Rinse coffee machine and confirm.

⇒ The coffee machine is rinsed.

10 CONFIGURATION

10.1 Calling up the maintenance level



1. Tap the Franke logo.



2. Enter the PIN. ***PIN codes [56]***
3. Press Ok.

10.2 PIN codes

Default PIN codes are assigned at the factory:

	Owner	Specialist	Cleaning staff	Operator
Default PIN	1111	2222	5555	7777
My PIN	■ ...	■ ...	■ ...	■ ...

The PINs for key (secured) products and On/Off machine can be viewed and changed with the owner role in the My settings > Access rights menu.

10.3 My settings menu tree

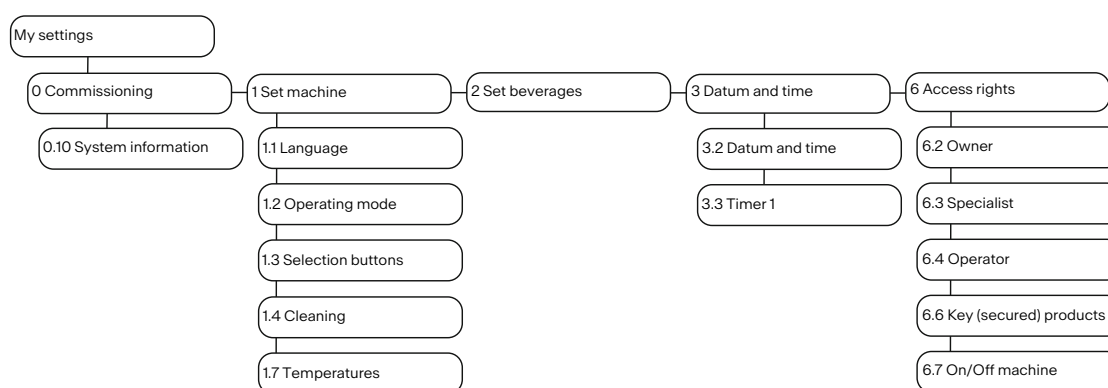

Depending on the configuration of your machine, individual menu items may or may not be displayed.

10.4 Input methods

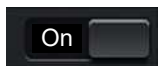

Tap the switch to switch between Yes/No or On/Off. The visible value is active.



Tap the arrow to display the selection and to select the option.



Drag the scale to adjust parameters. The framed value is active.



Tap the keyboard to enter text or numbers.



Press the button to carry out the corresponding settings, e.g. Start, Test.

10.5 My settings

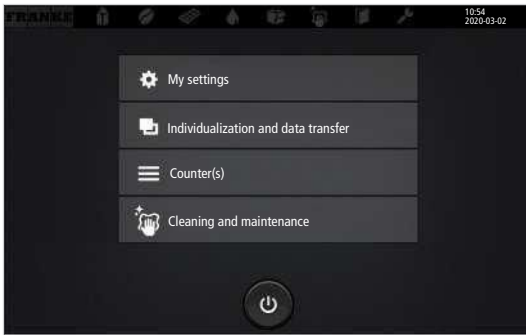

10.5.1 Menu 0 Commissioning

Menu item 0.10 System information



Here you will find information regarding the hardware and software versions of the machine and the configuration.

10.5.2 Menu 1 Set Machine

Menu item 1.1 Language

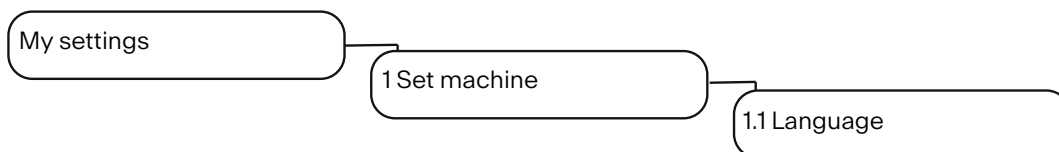

Parameter	Value range	Remarks
Select language	de, en, fr, bg, cs, da, es, es-US, et, fi, fr-CA, hr, hu, it, ja, ko, lt, lv, nl, no, pl, pt-BR, ro, ru, sk, sl, sr, sv, tr, th, uk, zh-CN, zh-TW, ar, he	The language is immediately switched on the user interface

Menu item 1.2 Operating mode

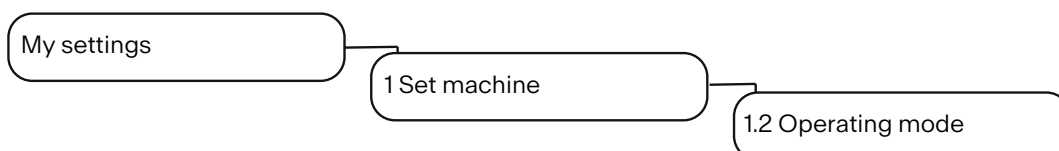

Operating mode

Usage scenario > Non-self-service

Parameter	Value range	Remarks
Usage scenario	<ul style="list-style-type: none"> - Non-self-service - (Self-service) 	
Products per page	<ul style="list-style-type: none"> - 4 - 9 - 16 	<ul style="list-style-type: none"> - Number of products displayed simultaneously - Default: 4
Depiction	<ul style="list-style-type: none"> - Photo-realistic - Iconized 	Default: Photo-realistic
Automatic mode	<ul style="list-style-type: none"> - Yes - No 	<ul style="list-style-type: none"> - Yes: All pre-selected products are dispensed without additional button input. - No: Each product must be triggered with the start button. - Default: No
Pause between products	1-10 seconds	<ul style="list-style-type: none"> - Appears if automatic mode is activated - Increment: 1
Shot timer	<ul style="list-style-type: none"> - Yes - No 	

Parameter	Value range	Remarks
Purge the steam wand	<ul style="list-style-type: none"> - Yes - No 	<ul style="list-style-type: none"> - Yes: The steam icon appears in the beverages overview. This enables manual purging. - No: no steam icon appears in the beverages overview - Default: No - Under Individualization and data transfer > Configure application > Cash register display, there is a parameter of the same name with the same function. The settings of both parameters are automatically synchronized.

Usage scenario > Self-service

Parameter	Value range	Remarks
Usage scenario	<ul style="list-style-type: none"> - Self-service - (Non-self-service) 	
Operating mode	<ul style="list-style-type: none"> - Quick Select - Inspire Me 	<ul style="list-style-type: none"> - Default: Quick Select - In the Self-service usage scenario, the user can choose between Quick Select and Inspire Me (Inspire Me not available for A400).
Products per page	<ul style="list-style-type: none"> - 6 - 12 - 20 	<ul style="list-style-type: none"> - Number of products displayed simultaneously - Default: Depends on the coffee machine
Adapt beverages	<ul style="list-style-type: none"> - Yes - No 	<ul style="list-style-type: none"> - Possibility for self-service customers to modify the selected beverage in accordance with the allocation of the selection buttons - Default: No
Custom images	<ul style="list-style-type: none"> - Yes - No 	<ul style="list-style-type: none"> - Activate customized images - For Self-service usage scenario, Quick Select operating mode - Default: No

Usage scenario > Personalized

Parameter	Value range	Remarks
Operating mode	Personalized	If a configuration was imported in the individual operating mode, only individual parameters of the application scenarios Self-service and Non-self-service are available under the menu item 1.2 Operating mode

Options

Parameter	Value range	Remarks
Hide cancel button	<ul style="list-style-type: none"> - Yes - No 	<ul style="list-style-type: none"> - Display the button for canceling the product - Default: No

Parameter	Value range	Remarks
Audible signal for beverage preparation	- Yes	Beeps when the product is ready
	- No	
Audible signal for error messages	- Yes	Beeps in a 3-second cycle if a resource is missing
	- No	

Menu item 1.3 Selection buttons

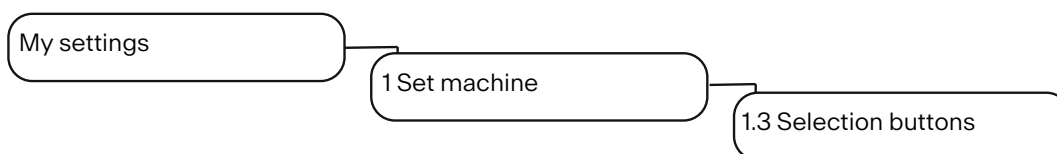

Parameter	Value range	Remarks
Function	<ul style="list-style-type: none"> - Small - Medium - Large - 2x - Decaf - Flavor 1–6 - Extra Shot - Iced - Espresso Shot 	<ul style="list-style-type: none"> - A maximum of 24 selection buttons can be assigned with various product options in the service menu. The product options appear in the Beverage Selection status. - With up to 8 configured selection buttons, buttons 1-4 are displayed on the left, the remaining buttons on the right - If more than 8 selection buttons are configured, buttons 1-6 are displayed on the left, the remaining buttons are displayed on the right - 9 or more buttons are displayed at a reduced size <p>Recommendation:</p> <ul style="list-style-type: none"> - Selection buttons on left-hand side: Select beverage size - Selection buttons on right-hand side: Select additional settings
PLU No.	PLU No.	<ul style="list-style-type: none"> - Store PLU number for price calculation (if PLU numbers are used) - Default: 0
Price list 0–4	Amount	<ul style="list-style-type: none"> - Set surcharge for the option. - The total price is calculated by the machine - Default: 0.00
Token 1–3	<ul style="list-style-type: none"> - 0 - 1 	<ul style="list-style-type: none"> - 0: The purchase with the corresponding token is not possible - 1: The product purchase with the corresponding token is possible

Menu item 1.4 Cleaning

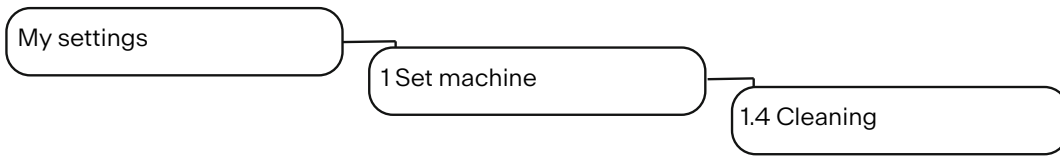

Parameter	Value range	Remarks
Buzzer	<ul style="list-style-type: none"> - Yes - No 	Audible prompt for actions during the cleaning process <ul style="list-style-type: none"> - No: Audible signal not active - Yes: Audible signal active - Default: No

Menu item 1.7 Temperatures

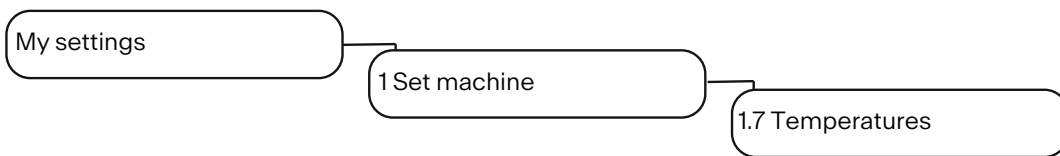

Consider the location, ambient temperature, and capacity utilization of the machine for these settings.

Parameter	Value range	Remarks
Coffee	-20 to +4 %	<ul style="list-style-type: none"> - The temperature in the brew boiler is configured by the service technician - The set temperature can be adjusted by percentages using the slide control
Hot water/steam	-10 to +0 %	<ul style="list-style-type: none"> - The temperature in the hot water/steam boiler is configured by the service technician - The set temperature can be adjusted by percentages using the slide control
Tea water	-20 to +10 %	<ul style="list-style-type: none"> - The temperature in the hot water boiler is configured by the service technician - The set temperature can be adjusted by percentages using the slide control

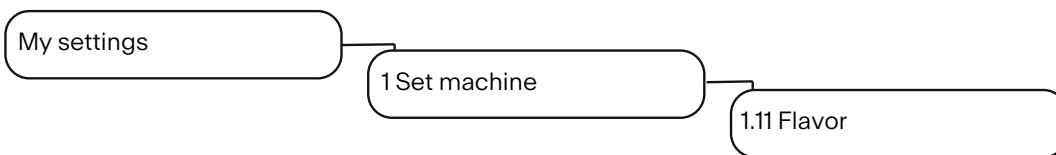
Menu item 1.11 Flavor

Parameter	Value range	Remarks
Counting active	- Yes	- Yes: Flavor products are counted
	- No	- No: Flavor products are not counted
		- Default: No

Flavor 1-6

Parameter	Value range	Remarks
Flavor 1-6	List of syrup types	- Only the syrup types stored here will be available later for the beverage settings
Only a small amount of syrup left	0-5000 ml	- Input of remaining quantity for which the Syrup type 1-6 almost empty message appears - Default: 200 ml
Syrup empty	0-5000 ml	- Input of remaining quantity for which the Syrup type 1-6 empty message appears. The syrup type is then blocked. - Default: 10 ml

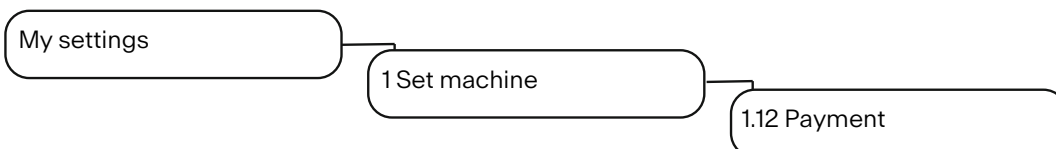
Menu item 1.12 Accounting

The service technician determines the accounting settings according to your wishes.

Parameter	Value range	Remarks
Accounting active	- Yes	- Switching accounting on/off
	- No	- Default: No

Menu item 1.14 Edge lighting

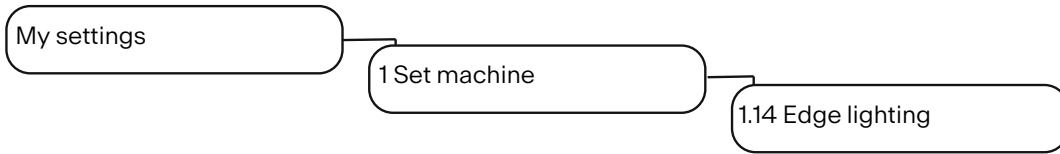

Parameter	Value range	Remarks
Select lighting	<ul style="list-style-type: none"> - Off - Red, green, blue, yellow, cyan, magenta, white - Flashing - Color gradient - User-defined 	<ul style="list-style-type: none"> - Off: no edge lighting - Red, green, etc.: edges illuminated in the selected color - Flashing: flashing light - Color gradient: color changes continuously - User-defined: colors can be defined individually by the input of RGB values - Default value: color gradient
Red lighting	0-100 %	To input RGB values when a user-defined color has been selected for the lighting
Green lighting		
Blue lighting		
Error display via edge lighting	<ul style="list-style-type: none"> - Yes - No 	<ul style="list-style-type: none"> - Yes: Error display via edge lighting active - No: no error display via edge lighting

Menu item 1.17 Resources



Is only supported when using the filter model (Individual Operating Mode).

Bean types

Parameter	Value range	Remarks
Bean hopper pos. 1-3	<ul style="list-style-type: none"> - None - Medium Espresso roast - Medium roast - Medium decaffeinated roast - Own bean type 1-6 	Default settings for A300: <ul style="list-style-type: none"> - Pos. 1: Medium Espresso roast - Pos. 2: Medium roast
Insertion flap	<ul style="list-style-type: none"> - None - Medium Espresso roast - Medium roast - Medium decaffeinated roast - Own bean type 1-6 	

Powder

Parameter	Value range	Remarks
Powder hopper pos. 3-4	<ul style="list-style-type: none"> – None – Powdered chocolate – Powdered white chocolate – Milk powder – Own powder type 1–6 	Preset for A300: <ul style="list-style-type: none"> – Pos. 3: Milk powder – Pos. 4: Powdered chocolate
Prepare powder system	Button	The coffee machine guides through the process

Milk

Parameter	Value range	Remarks
Milk type 1-2	<ul style="list-style-type: none"> – None – Whole milk – Reduced-fat milk – Low-fat milk – Skim milk – Soy milk – Lactose-free milk – Own milk type 1–6 	
Prepare milk type 1-2	Button	The coffee machine guides through the process

Flavor

Parameter	Value range	Remarks
Flavor pos. 1-3/1-6	<ul style="list-style-type: none"> – None – Own flavor type 1-6 – Amaretto – Apple – Etc. 	
Prepare flavor type 1-3/1-6	Button	The coffee machine guides through the process

10.5.3 Menu 2 Customize beverages

You can save each product in three user-specific variations. The original cannot be changed.

Only parameters that are relevant for the product are displayed.

The percentage specifications are always based on the preset value.

For tips on setting the parameters, see the chapter ***Help with problems concerning product quality*** [82].

All values configured in menu 2 are saved in the configuration and can be re-imported.



1	Select variant	2	Select area
3	Save settings	4	Select product
5	Confirm variant	6	Prepare a test product
7	Adjust parameters		

Setting beverages

Desired action	Menu item	Information/instruction	Number
Select a product		Use the selection arrows to select the product to be defined, then select the variation to be edited	4, 1
Change product name	General	Enter product name and select product text	2, 7
Adjust price (only available when payment is activated)	General	Determine PLU, prices, and tokens; select the Free option	7
Adjust water quantity, grinders, brewing quantity, and pressure	Coffee	Adjust parameters	2, 7
Adjust milk quantity	Milk	Adjust the milk quantity in percent	2, 7
Adjust the foam quantity	Foam	Adjust the foam quantity in percent	2, 7
Prepare a test product	Test	Press Test to prepare the selected product using the modified settings	6
Assign a beverage variation that is to be prepared with this product selection		Select the variant, then confirm with the checkmark	1, 5
Save beverage settings	Save		3

10.5.4 Menu 3 Date and time

Menu item 3.2 Date and time

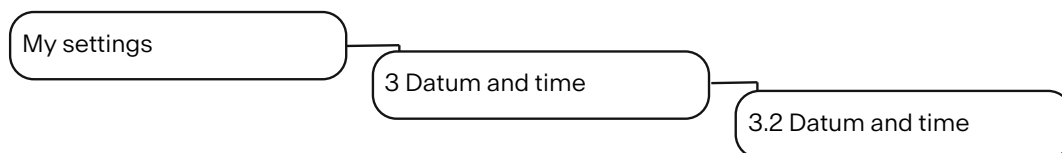

Parameter	Value range	Remarks
12/24-hour display	- 12 hours - 24 hours	
Day	1-31	Set the day
Month	1-12	Set the month
Year	0-63	Set the year
Hour	0-23/0-11	Set the hour
Minute	0-59	Set the minute
Time zone	Time zone selection list	- Select the time zone from the list - Default: UTC+0100 (Europe) Zurich

Menu items 3.3–3.6 Timer 1–4

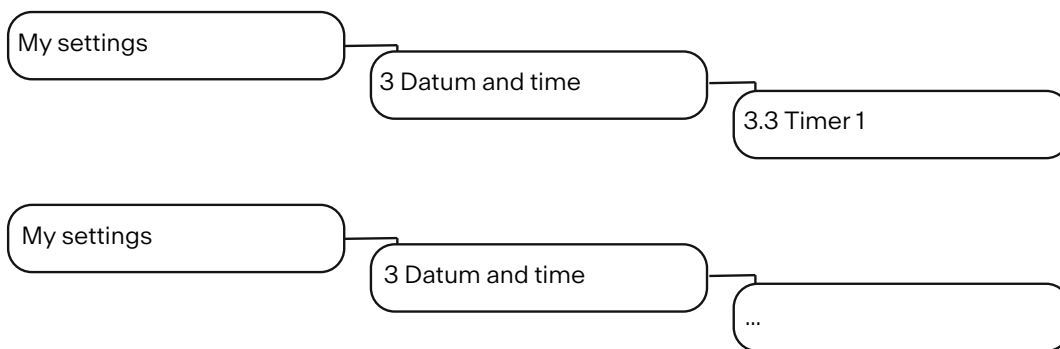

Switching on automatically

Parameter	Value range	Remarks
Active	- Yes - No	Switch timer on or off
Hour	0–23/0–11	Select switch-on time (hour)
Minute	0–59	Select switch-on time (minute)
Monday, Tuesday, Wednesday, Thursday, Friday, Saturday, Sunday	- Yes - No	Activate or deactivate the timer for each day

Switching off automatically

Parameter	Value range	Remarks
Active	- Yes - No	Switch timer on or off
Hour	0–23/0–11	Select switch-off time (hour)
Minute	0–59	Select switch-off time (minute)
Monday, Tuesday, Wednesday, Thursday, Friday, Saturday, Sunday	- Yes - No	Activate or deactivate the timer for each day

10.5.5 Menu 4 Nutritional value information

Menu item 4.1 Milk

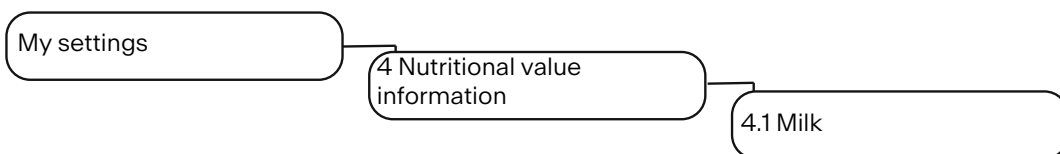

[Milk type 1]/[Milk type 2]

Nutritional values per 100 ml

Parameter	Value range	Remarks
Sugars	0.0–500.0 g Increment 0.1	Enter sugar content in g
Fat	0.0–50.0 % Increment 0.1	Enter fat content in %
Protein	0.0–30.0 g Increment 0.1	Enter protein content in g
Calories	0–2000 kcal Increment 1	Enter calorific value in kilocalories (kcal)
[List of common allergens and ingredients]	– Yes – No	– Enter ingredients or allergens – Default: No
Other allergens	Free text input	Enter ingredients or allergens that are not included in the list

Menu item 4.2 Flavor

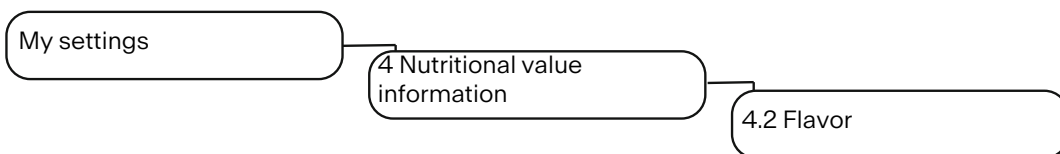

Menu item 4.3 Powder

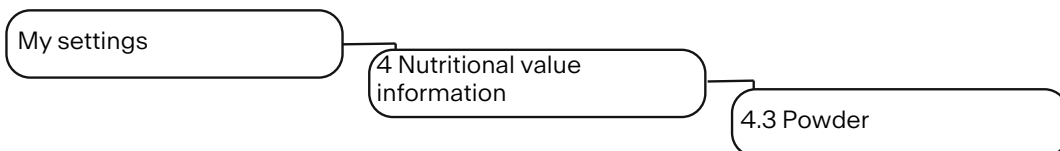

Powder dosing unit position 3/4

Nutritional values per 100 ml

Parameter	Value range	Remarks
Sugars	0.0–500.0 g Increment 0.1	Enter sugar content in g
Fat	0.0–50.0 % Increment 0.1	Enter fat content in %
Protein	0.0–30.0 g Increment 0.1	Enter protein content in g
Calories	0–2000 kcal Increment 1	Enter calorific value in kilocalories (kcal)
[List of common allergens and ingredients]	<ul style="list-style-type: none"> – Yes – No 	<ul style="list-style-type: none"> – Enter ingredients or allergens – Default: No
Other allergens	Free text input	Enter ingredients or allergens that are not included in the list

10.5.6 Menu 6 Access rights



The access rights option makes it possible to assign different PIN codes for different tasks and roles. Three access levels (owner, specialist, and operator) can be defined for accessing the maintenance level.

Menu item	PIN code (default values)
6.2 Owner	1111
6.3 Specialist	2222
6.4 Operator	7777
6.5 Cleaning staff	5555
6.6 Key (secured) products	8888
6.7 On/Off machine	9999

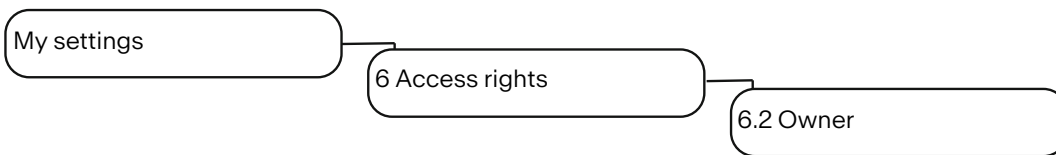
Menu item 6.2 Owner

Parameter	Value range	Remarks
Change PIN	Enter new PIN	Default PIN: 1111 Authorization: <ul style="list-style-type: none"> - Change a child role PIN - Producing test products - Add, delete, and modify products (limited functionality) - Show counters - Cleaning the system
PIN set	<ul style="list-style-type: none"> - Yes - No 	<ul style="list-style-type: none"> - Yes: PIN is active - No: PIN is not active
Activate user profile	<ul style="list-style-type: none"> - Yes - No 	<ul style="list-style-type: none"> - Yes: User profile is active - No: User profile is not active
Open door to log on	<ul style="list-style-type: none"> - Yes - No 	<ul style="list-style-type: none"> - Yes: Registration only works when the door is open - No: Registration works even when the door is closed

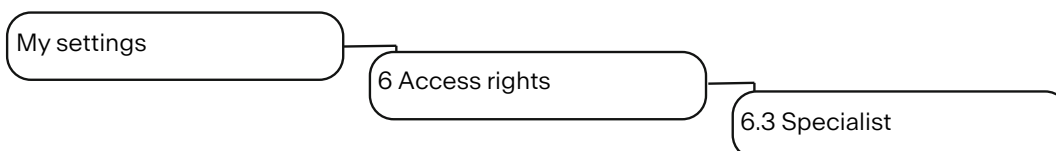
Menu item 6.3 Specialist

Parameter	Value range	Remarks
Change PIN	Enter new PIN	Default PIN: 2222 Authorization: <ul style="list-style-type: none"> - Limited access to Service menu, My Settings, Individualization and data transfer, Counters and Cleaning and maintenance
PIN set	<ul style="list-style-type: none"> - Yes - No 	<ul style="list-style-type: none"> - Yes: PIN is active - No: PIN is not active
Activate user profile	<ul style="list-style-type: none"> - Yes - No 	<ul style="list-style-type: none"> - Yes: User profile is active - No: User profile is not active
Open door to log on	<ul style="list-style-type: none"> - Yes - No 	<ul style="list-style-type: none"> - Yes: Registration only works when the door is open - No: Registration works even when the door is closed

Menu item 6.4 Operator

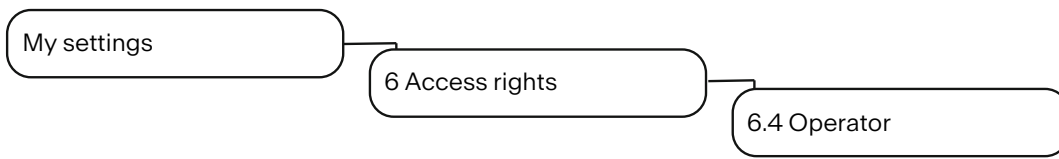

Parameter	Value range	Remarks
Change PIN	Enter new PIN	Default PIN: 7777 Authorization: <ul style="list-style-type: none"> - Show counters - Cleaning the system - Update software via USB stick
PIN set	- Yes	- Yes: PIN is active
	- No	- No: PIN is not active
Activate user profile	- Yes	- Yes: User profile is active
	- No	- No: User profile is not active
Open door to log on	- Yes	- Yes: Registration only works when the door is open
	- No	- No: Registration works even when the door is closed

Menu item 6.5 Cleaning staff

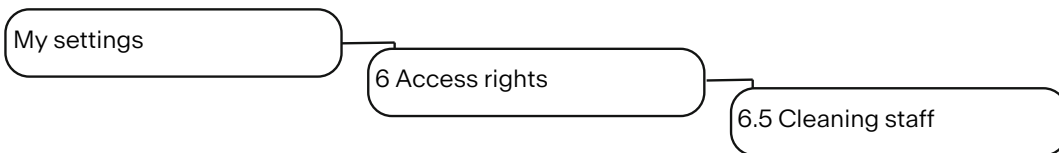

Parameter	Value range	Remarks
Change PIN	Enter new PIN	Default PIN: 5555 Authorization: <ul style="list-style-type: none"> - Only access to Cleaning and maintenance
PIN set	- Yes	- Yes: PIN is active
	- No	- No: PIN is not active
Activate user profile	- Yes	- Yes: User profile is active
	- No	- No: User profile is not active
Open door to log on	- Yes	- Yes: Registration only works when the door is open
	- No	- No: Registration works even when the door is closed

Menu item 6.6 Key (secured) products

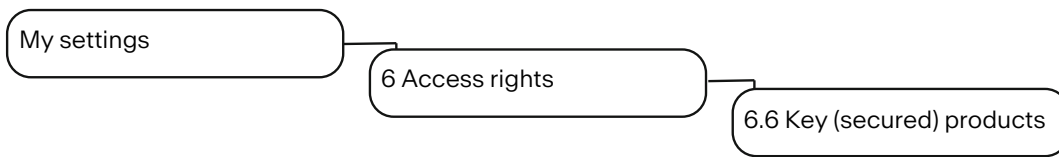

Key (secured) products can be prepared only after a PIN code has been entered.

Parameter	Value range	Remarks
Change PIN	Enter new PIN	Default PIN: 8888
PIN set	- Yes	- Yes: PIN is active
	- No	- No: PIN is not active
Activate user profile	- Yes	- Yes: User profile is active
	- No	- No: User profile is not active

Menu item 6.7 On/Off machine

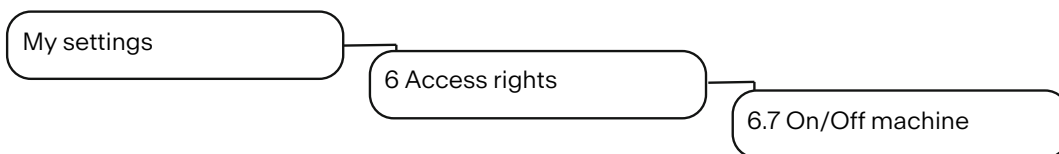

PIN code that authorizes to switch the machine on and off.

Parameter	Value range	Remarks
Change PIN	Enter new PIN	Default PIN: 9999
PIN set	- Yes	- Yes: PIN is active
	- No	- No: PIN is not active
Activate user profile	- Yes	- Yes: user profile is active
	- No	- No: user profile is not active
		- Default: no

11 INDIVIDUALIZATION AND DATA TRANSFER

11.1 Overview

This menu provides you with the following options:

- Use existing Franke media for screen savers or as advertising media
- Upload and view your own media objects on the machine
- Use your own media for screen savers or as advertising media
- Configure the behavior of the different operating modes and the screen saver
- Save settings
- Create regular backups of your machine to a USB stick
- Perform downloaded digital services updates

11.2 Individualization and data transfer menu tree

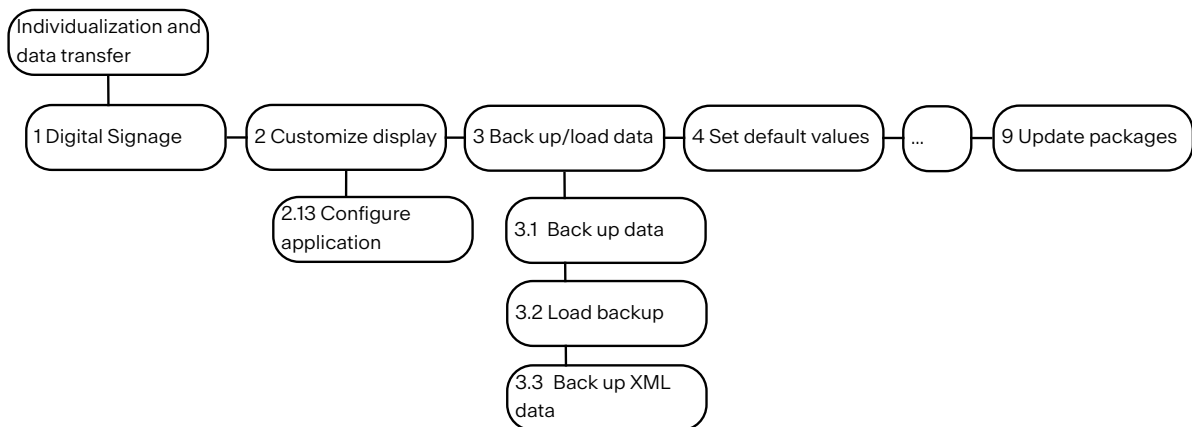

By using 4 Set default values, selected parameters can be reset to the configured values.

8 Eject USB stick logs off connected USB sticks. If a USB stick is being used, the menu item will appear in green; otherwise it appears in orange.

The multimedia functions can only be used in **Quick Select [45]** operating mode.

The digital cleaning instructions (PKT) are integrated directly into the software from software version 4.20 onwards.

11.3 Multimedia functions

- Use image files or video files as advertising media
- Use image files or video files as a screen saver

11.4 Manage Digital Signage via USB stick

You can maintain the selection and display times of your advertising media (digital signage) in a freely accessible web tool. To do this, export and import the corresponding file with a USB stick.

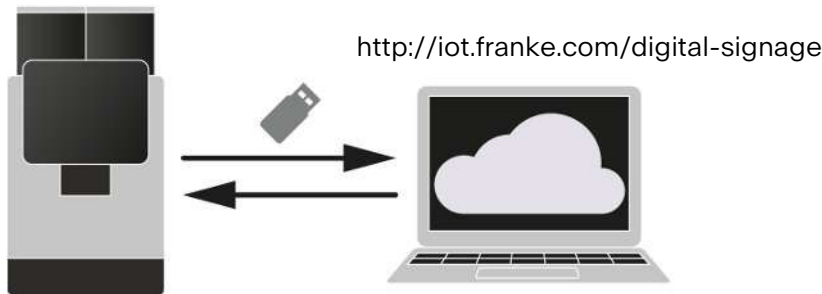

- ✓ The coffee machine has software version 4.0 or higher.
- 1. Connect a USB stick to the machine.
- 2. Go to menu item Individualization and data transfer > 1 Digital Signage.
- 3. Tap the Export Digital Signage button.
- 4. For the parameter Eject USB stick select the value Yes.
- 5. Tap the Export button.
 - ⇒ The coffee machine saves the *.bundle file to the USB stick.
- 6. Remove the USB stick.
- 7. Connect the USB stick to any computer.
- 8. In the browser, go to the website <http://iot.franke.com/digital-signage>.
- 9. Transfer the *.bundle file from the USB stick to the website via drag&drop or file explorer.
 - ⇒ The configuration options for Digital Signage are displayed.
- 10. Make the desired settings.
- 11. Rename the file via the pencil icon in the upper left-hand corner, if desired.
- 12. Tap the Download button on the bottom left side of the window.
 - ⇒ The web page asks whether the changes made should be saved.
- 13. Confirm the question.
- 14. Select the Manual value.
- 15. Tap the Download bundle button.
 - ⇒ The downloaded *.bundle file ends up in the download folder of the computer.
- 16. Move the *.bundle file to the USB stick.
- 17. Remove the USB stick.
- 18. Connect the USB stick to the machine.
- 19. Go to menu item Individualization and data transfer > 1 Digital Signage.
- 20. Tap the Import Digital Signage button.
- 21. Select the revised *.bundle file.
- 22. Tap the Download and install button.
 - ⇒ The coffee machine adopts the new settings.

11.5 Configure application



Changes made will only take effect after the Save button is tapped.

11.5.1 Language settings

Parameter	Value range	Remarks
Language	– All available languages	
Switching language	– Yes – No	– Yes: a country flag appears in the top right corner during product selection. The languages defined under Language 1-6 appear by tapping the flag. If a language is selected, the translated beverage names and billing information will appear. After the duration specified under Timeout language switching has elapsed, the default language specified under Language reappears. – No: language switching is deactivated
Timeout for language change	20–120 s	Waiting time after which the coffee machine switches back to the default language set in Language or under the menu 1 Set machine > 1.1 Language.
Language 1-6	de, en, fr, bg, cs, da, es-ES, es-US, et, fi, fr-CA, hr, hu, it, ja, ko, lt, lv, nl, no, pl, pt-BR, ro, ru, sk, sl, sr, sv, tr, th, uk, zh-CN, zh-TW, ar, he	– Appears only if the value Yes is selected for Language change – Determines how many and which alternative languages are available during product selection

11.5.2 Operating mode

Parameter	Value range	Remarks
Operating mode	– Self-service – Quick Select – Non-self-service – Cash Register	
Hide cancel button	– Yes – No	
Display clock	– Yes – No	
Display brightness	15-100 %	
Audible signal for beverage preparation	– Yes – No	
Audible signal for error messages	– Yes – No	

11.5.3 Display [Operating mode]



Depending on the operating mode, different display parameters are available.

11.5.4 Nutritional value settings

Parameter	Value range	Remarks
Display nutritional value information	<ul style="list-style-type: none"> - Yes - No 	<ul style="list-style-type: none"> - Activate/deactivate the display of nutritional value information - The nutritional information can be entered in chapter Menu 4 Nutritional value information [68]
Further nutritional value information	Free text input	

11.5.5 Accounting

Parameter	Value range	Remarks
Select	<ul style="list-style-type: none"> - Coins - Cards - Customer card - Contactless - Cell phone - Bills 	
Display pop-up window	<ul style="list-style-type: none"> - Yes - No 	Activate/deactivate accounting pop-up window

11.5.6 Cup detection

Setting	Value range	Remarks
Filter beverages	<ul style="list-style-type: none"> - Yes - No 	<p>Yes: The product range is automatically based on the size of the cup under the spout.</p> <p>No: the product range is not filtered.</p>
Allow wrong cup	<ul style="list-style-type: none"> - Yes - No 	<p>Yes: Beverages can be prepared if the cup under the spout does not match the selected cup size on the screen.</p> <p>No: The machine will not start preparing beverages until the correct size of cup is under the spout.</p>
Allow wrong spout	<ul style="list-style-type: none"> - Yes - No 	Always set to No. This parameter currently has no function.

11.5.7 Cup monitoring



The parameters of the cup monitoring do not appear if the coffee machine has a camera-based (optical) cup recognition.

Parameter	Value range	Remarks
During rinsing	- Yes	
	- No	
During drink preparation	- Yes	
	- No	

11.5.8 Edge lighting

Setting	Value range	Remarks
Select lighting	- Off	
	- Color gradient	
	- Flashing	
	- User-defined	
	- Red	
	- Green	
	- Blue	
- etc.		
Error display via edge lighting	- Yes	If an error or message occurs, the edge lighting flashes in the respective color (yellow, orange or red).
	- No	

11.5.9 Transaction approval (API)



Parameters are not related to each other

The parameters Activate transaction approval and Allow Remote Control can cover similar use cases. However, the parameters are not related to each other.

Parameter	Value range	Remarks
Activate transaction approval	- Yes	The transaction approval enables interaction between the coffee machine and the third-party app. The use case is the same as for Remote Control, but instead of the Franke web app, the app from a third-party manufacturer is used.
	- No	
Allow Remote Control	- Yes	With Remote Control, the coffee machine refers to a QR code that leads to Franke's web app. The web app enables both beverage selection and payment via cell phone. Once payment has been successfully processed, the app triggers the beverage production.
	- No	

11.6 Loading/backing up data

11.6.1 Back up data

Desired action	Menu item	Information/instruction
Export a configuration and media	3.1 Back up data	<ul style="list-style-type: none"> – Export configuration – Back up Franke media – Back up your own media – Eject USB stick automatically – Display of file name

11.6.2 Load data

Desired action	Menu item	Information/instruction
Import configuration and media	3.2 Load backup	<ul style="list-style-type: none"> – Load backed up data (configuration, Franke media, your own media) – Eject USB stick automatically

11.6.3 Back up XML data

Desired action	Menu item	Information/instruction
Back up XML data	3.3 Back up XML data	<p>Export operating data such as maintenance data, error logs, or product and machine counters</p> <ul style="list-style-type: none"> – Eject USB stick automatically – Display of file name

11.7 Set default values

Desired action	Menu item	Information/instruction
Set default values	4 Set default values	<p>In the selected areas, restore the default values (e.g. variable and fixed data) or delete counters (product and machine counters) and files (product and error log, files)</p> <p>Confirm changes made by tapping the Apply button</p>

11.8 Activating configurations

If updates (menu bundle, software version, etc.) are transferred to the coffee machine via Dashboard Provisioning or Deployment or via USB stick, they must be activated on the coffee machine. The available update packages can be viewed in the Individualization and data transfer menu on the coffee machine.

✓ A configuration, a menu bundle, or a new software version was loaded onto the coffee machine via the **Provisioning or Deployment** dashboard.

1. Tap the Franke logo.

2. Enter the PIN.

3. Press OK.

⇒ In addition to the **Individualization and data transfer** menu, the number of available updates can be viewed.

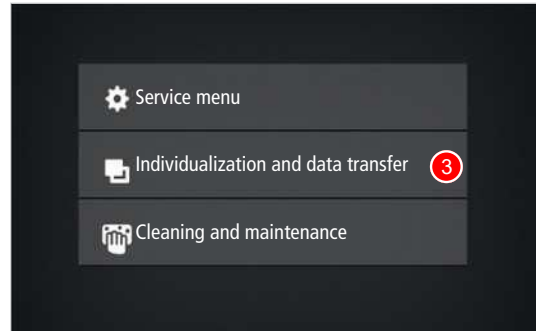

4. Select the **Individualization and data transfer** menu.

5. Select menu item 9 **Update packages**.

6. Select the desired update package and press the **Download and import** button.

⇒ The update package is imported.

7. Press the **Install** button.

⇒ The update package is installed.

12 TROUBLESHOOTING

12.1 Error messages

When an error occurs, the machine displays an error message which provides instructions on how to rectify the issue.

Non-self-service mode

Errors in the non-self-service mode are indicated via a highlighted symbol. Tap the symbol for further information.

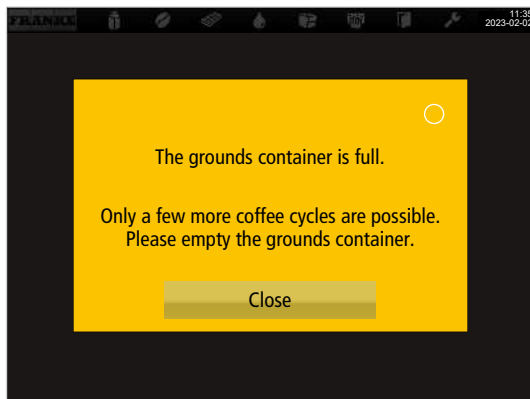

Self-service operating mode

When the self-service mode is selected, an error is indicated via a colored triangle in the upper right-hand corner of the operator panel. Tap the symbol for further information.



If the entire system is affected by an error, error messages will appear automatically. The machine must be restarted in the event of serious errors.

- a) To restart the machine, switch it off via the main switch  .
- b) Wait a minute and then switch it back on again.
- c) Check the power supply if the machine fails to start.
- d) Contact your service technician if the machine cannot be started or if you are unable to rectify the error.

12.1.1 Color code for error messages

-
-
-
-
-

12.2 Troubleshooting the system

Error message/problem	Possible cause	Measure
Milk is frozen	Cooling unit target temperature is set too low	Set target temperature 1–2 °C higher <ul style="list-style-type: none"> – SU05 cooling unit: Press and hold the Set button on the temperature controller until the target temperature flashes. Use the navigation buttons to increase the target temperature. Use the Set button to confirm the new target temperature. – KE200: A temperature controller is located to the rear of the KE200. Use this to set the required temperature
Milk is frozen (water in the cooling chamber)	The cooling unit door seal is not leak-tight	Make sure that the seal is fitted correctly and that the door closes properly
Cooling unit milk temperature is not being reached	Inadequate air circulation around cooling unit	Ensure that the required minimum clearance is present between the cooling unit and the wall (at least 50 mm)
No milk or just milk foam	Suction hose/milk line has a leak	Check the position of the spout insert and, if necessary, clean it. SU05 cooling unit: Check the O-ring on the suction hose coupling. Check the suction hose and, if necessary, replace it
Milk is not flowing correctly out of the milk spout	The milk spout was not installed correctly when it was last cleaned	Start coffee machine cleaning, and install the milk spout as per the instructions on the touch screen.
Error message E79 Flow meter error	Water flow disrupted	Check the water tank/main water connection coupling <p>If the error message appears while a product is being dispensed, the brewing module strainer is probably blocked</p> <ul style="list-style-type: none"> – Increase the grind coarseness and/or reduce the grind quantity – Remove the brewing module and rinse it out – Start the coffee machine cleaning process

Error message/problem	Possible cause	Measure
Touch screen not responding correctly	Overloaded machine software	<p>There are two different troubleshooting methods:</p> <ul style="list-style-type: none"> – Method 1: Press and hold the red button on the right-hand side of the operator panel for 10 seconds to restart – Method 2: Disconnect the coffee machine from the power grid. Wait 1 minute before reconnecting the coffee machine to the power grid. Briefly press the red button on the right-hand side of the operator panel to switch it on

12.3 Tips for good coffee beverages



NOTICE

Poor beverage quality

The oil from the coffee beans is deposited on the inside of the bean hopper as a thin film of oil. This deposited oil ages quickly and impairs the taste of the beverages produced.

- a) Remove the oil film from the inside of the bean hopper on a daily basis.
- b) To do this, use a dry cloth or a cloth moistened only with water.
- c) Do not use any cleaners, as these alter the taste of the coffee.



The aromas of the coffee beans evaporate in the bean hopper as a result of heat and air exchange. The quality will have already deteriorated after 3 hours.

- a) Coffee beans should not be moist.
- b) Seal any open coffee bean packs in an airtight manner.
- c) Do not store coffee beans in a refrigerator or freezer.
- d) Only fill the coffee beans into the bean hopper that you will need for the next 3 hours.

12.4 Help with problems concerning product quality

Problem	Possible causes	Possible remedies
Coffee tastes stale	Grind too coarse	Select a finer grind Setting the grind coarseness [38]
	Too little coffee	Increase coffee quantity Menu 2 Customize beverages [64]
	Temperature too low	Increase temperature Menu 2 Customize beverages [64]
	Coffee is stale	Use fresh coffee
Coffee tastes strange	Bean hopper not locked correctly	Check the bean hopper latching mechanism
	Poor grind	Contact customer service

Problem	Possible causes	Possible remedies
	Minimal coffee usage	Fill a small amount of coffee beans into the bean hopper
	Spoiled coffee beans	Replace coffee beans
	Cleaner residue	Rinse the machine
	Dirty cup	Check the dishwasher
	Poor water quality (chlorine, hardness, etc.)	Have water quality tested Water quality [31]
Coffee tastes bitter	Temperature too high	Reduce coffee temperature Menu 2 Customize beverages [64]
	Grind too fine	Select a coarser grind Setting the grind coarseness [38]
	Coffee quantity too low	Increase coffee quantity Menu 2 Customize beverages [64]
	Roast too dark	Use lighter coffee roast
Coffee tastes sour	Temperature too low	Increase coffee temperature Menu 2 Customize beverages [64]
	Roast too light	Use darker coffee roast
	Grind too coarse	Select a finer grind Setting the grind coarseness [38]
Consistency of powder products	Viscous	Use less powder, use more water
	Watery	Use more powder, use less water
	Powder clumping or moist	Clean and dry powder system
Taste of powder products	Too sweet	Use less powder, use more water
	Not sweet enough	Use more powder, use less water
	Strange taste	Clean powder system

13 DECOMMISSIONING

13.1 Preparing for decommissioning

1. Clean the machine using the automatic *Cleaning [49]* function.
2. Empty the bean hopper and powder hopper.
3. Clean the bean hopper and powder hopper.
4. Clean the grounds container.
5. Empty the milk container.
6. Clean the milk container and container lid.
7. Clean the inside of the milk hose with a brush.
8. Clean the suction filter with a twisted-in-wire brush.
9. Clean the reversible adapter.

13.2 Back up data



Back up the data if the machine is to be recommissioned later or if the machine is to be replaced by a machine of the same type.

This manual applies to coffee machines without Franke Digital Services.

1. In the service menu under Customization and data transfer, go to the menu item Go to Back up/load data.
 - ⇒ The machine data and the configuration will be saved on the USB stick.
2. Go to Back up/load data.
3. Connect the USB stick and Select Export.
4. Tap Yes to eject the USB stick after the backup.

13.3 Short-term decommissioning (up to 3 weeks)

- ✓ The machine remains in place.
1. Clean the machine using the automatic cleaning function. *Cleaning [49]*
 2. Go to the energy-saving mode.
 3. Disconnect the machine from the power supply.
 4. Close the water supply if the machine has a main water connection.
 5. Clean any add-on units.
 6. Switch off the add-on units and disconnect them from the power grid.

13.4 Long-term decommissioning



NOTICE

Functionality of the machine is impaired in the event of long-term decommissioning and storage

If you plan to start using your machine again at a later date, it is essential that service measures are implemented. The coffee machine must be maintained, installed, and cleaned before preparing any beverages.

- a) Contact the Franke Service team for information regarding proper decommissioning and storage.
- b) Have your coffee machine drained by your service technician.
- c) Remedial maintenance may be required when commissioning the machine if it has been stored in excess of 6 months.

13.5 Transport and storage



Protect the machine from mechanical damage and adverse environmental conditions during transport and storage.

Transport conditions

Protect the machine from the following risks:

- Vibrations
- Dust
- Sunlight
- Falling or tipping over
- Slipping during transport
- Frost, if machine has not been drained and emptied completely

Storage conditions

- If the machine has been completely drained and emptied, it can be stored at -10 °C to 50 °C
- Relative humidity: max. 80 %
- It must be fixed in a suitably stable position throughout
- The machine should be in an upright position
- The machine should be empty and the system drained
- Machine and loose parts packaged, preferably in their original packaging

13.6 Recommissioning after prolonged periods of storage or non-use



NOTICE

Deterioration in storage

Parts may no longer function as they should if they have been stored or unused for periods in excess of 6 months.

- a) Contact your service technician for information regarding repairing and recommissioning your machine.

14 DISPOSAL OF PARTS

Disposal of consumables

- Beans, powder and coffee grounds can be composted.
- Observe the information on the label when disposing of any unused cleaning supplies.
- Dispose of the fluids from the cleaning container or the drip tray in the wastewater system.

Disposal of the machine and other devices



The appliance complies with European Directive 2012/19/EU regarding Waste Electrical and Electronic Equipment (WEEE) and must not be disposed of with household waste.



Dispose of electronic parts separately.



Dispose of plastic parts in accordance with their marking.



Two people are required for transporting the coffee machine.

15 TECHNICAL DATA

Device type	A1000 (FCS4059)
Dimensions: Width/height/depth (mm)	340/540/600
Weight (kg)	58
Bean hopper capacity (kg)	0,6 or 1,2
Twin bean hopper capacity (kg)	2 x 0,6 or 2 x 1,2
Bean hopper capacity, one grinder (kg)	1,8
Powder hopper tall, capacity (kg)	1,2
Powder hopper low, capacity (kg)	0,6
Noise emission (dB(A))	< 70
Ambient temperature (°C)	10-32
Humidity (%)	Max. 80
External wastewater tank volume (l)	16
Grounds container capacity	60-110 cakes, depending on the grind quantity
Brew boiler	Volume (l): 0,9 Operating pressure (bar): 8
Hot water boiler	Volume (l): 0,9 Operating pressure (bar): 12
Steam boiler	Volume (l): 0,9 Operating pressure (bar): 3

15.1 Capacities in accordance with DIN 18873-2:2016-02

Hourly capacity	Single preparation (cups per hour)	Double preparation (cups per hour)
Espresso	160	238
Coffee/Café crème	109	141
Hot water (200 ml)	164	-
Cappuccino	156	224
Latte macchiato	154	188
Milk coffee	138	188
Chocolate	129	-

15.2 Electrical connection data

Voltage	Main power connection	Power rating (max.)	Fuse	Frequency
220–240 V	1LNPE	5590-7920 W	30 A	50-60 Hz
220–240 V	2LPE	4500-5300 W	16 A	60 Hz
380 V	3LPE	6300 W	16 A	60 Hz
380–415 V	3LNPE	6300-7500 W	16 A	50-60 Hz

INDEX

Numeric

5-step method 12, 49

A

Ambient conditions 87

B

Beans

Disposal 86

Beverage

Preparing 45, 46, 48

C

Cancel button 12

Capacities 87

Cleaning 50

Cleaning container

Disposal of fluid 86

Cleaning supplies

Disposal 86

Cleaning tablets 16

Coffee beans

Filling 33

Coffee grounds

Disposal 86

Coffee machine

Cleaning 50

Credit Mode 28

D

Dashboard 12

Decommissioning 84

Dimension 29

Disposal 86

Drip grid extension 17

Drip tray

Disposal of fluid 86

E

Electronic parts

Disposal 86

Error message

Color code 14

Depiction 14

Error messages 80

F

Features 36, 43

G

Grind coarseness 38

Grinder adjustment wrench 17

I

Intended use 7

M

Main water connection

Requirements 31

Manual set 16

Measuring cup 16

Media

Back up 78

Loading 78

Milk system cleaning agent

Cartridge 16

Minimum clearances 30

O

Operating mode

Cash Register 27

Non-self-service mode 80

Quick Select 27

Self-service 80

P

PIN codes 56

Plastic parts

Disposal 86

Powder

Disposal 86

Product quality 83

R

Requirements	12
--------------	----

S

Safety	8
Screen	
Cleaning	54
Wipe protection	54
Spout	45, 46, 48
Start button	12
Symbols	12
Dashboard	12
Instructions	12
Software	12

T

Tips	12
Transport	86
Troubleshooting	82
Machine error	80
Type code	20
Type plate	18

U

User manual	16
-------------	----

W

Wastewater tank (external)	87
Water quality	31
Wipe protection	54



Franke Kaffeemaschinen AG

Franke-Str. 9
CH-4663 Aarburg
Switzerland
Tel. +41 62 787 31 31
www.franke.com

Franke Coffee Systems GmbH

Franke Strasse 1
97947 Grünsfeld
Deutschland
Tel.: +49 9346 9278 0
Fax: +49 9346 9278 100
www.franke.de

**Franke Coffee Systems
UK Limited**

6A Handley Page Way,
Old Parkbury Lane,
Colney Street,
St Albans,
Hertfordshire, AL2 2DQ
England
Tel.: +44 1923 635700
Fax: +44 1923 635701
www.franke.com

**Franke Coffee Systems
Americas**

800 Aviation Parkway
Smyrna, TN 37167
USA
Tel.: +1 615 462 4265
Fax: +1 615 462 4400
www.franke.com

coffee.franke.com